



# HYUNDAI

## **Rettungsdatenblätter für Rettungskräfte**

### **Hinweis:**

Diese Rettungsdatenblätter wurden ausschließlich für Rettungskräfte erstellt, die über eine spezielle Ausbildung auf dem Gebiet der technischen Hilfeleistung nach Verkehrsunfällen und der damit verbundenen Tätigkeiten verfügen. Ferner enthalten die Rettungsdatenblätter ausschließlich Informationen über Fahrzeuge, die zum Verkauf in Deutschland bestimmt sind.

Spezifikationen und Sonderausstattungen der Hyundai Fahrzeuge sowie das Fahrzeugangebot unterliegen stetig etwaigen Änderungen. Daher behält sich Hyundai inhaltliche Anpassungen bzw. Änderungen an den Rettungsdatenblättern jederzeit ausdrücklich vor.

Die in diesem Leitfaden enthaltenen Informationen sind nicht für Endkunden und ebenfalls nicht für Werkstätten und Händler bestimmt. Endkunden können den Bordbüchern ihres jeweiligen Fahrzeuges detaillierte Informationen zu den Funktionen ihres Fahrzeuges sowie wichtige Sicherheitshinweise zur Fahrzeug- und Insassensicherheit entnehmen. Werkstätten und Händler erhalten Reparaturinformationen über die ihnen bekannten Bezugsquellen.



# Rettungsdatenblätter

## A

• Accent (3-Türer)	LC	ab 2000
• Accent (5-Türer)	LC	ab 2000
• Accent (3-Türer)	MC	ab 2006
• Accent (4-Türer)	MC	ab 2006
• Atos	MX/MXL/MXI	ab 1998

## C

• Coupe	GK	ab 2002
• Coupe	GK	ab 2006

## E

• Elantra (4-Türer)	XD	ab 2000
• Elantra (5-Türer)	XD	ab 2000

## G

• Genesis Coupe	BK	ab 2011
• Genesis	DH	ab 2014
• Getz (3-Türer)	TB	ab 2002
• Getz (5-Türer)	TB	ab 2002
• Grandeur	TG	ab 2005

## H

• H-1	H1	ab 1998
• H-1	H1	ab 2008
• H-350 (Cargo)	EU	ab 2015
• H-350 (Fahrgestell)	EU	ab 2015
• H-350 (Bus)	EU	ab 2016

## I

• i10	PA	ab 2008
• i10	PA	ab 2011
• i10	IA	ab 2014
• i20 (3-Türer)	PB	ab 2008
• i20 Coupe	GB	ab 2015
• i20 (5-Türer)	PB	ab 2008
• i20 (5-Türer)	GB	ab 2014
• i30	FD/FDH	ab 2008
• i30	GDH	ab 2012
• i30	PDE	ab 2017
• i30 Coupe	GDH	ab 2013
• i30 Fastback	PDE	ab 2017
• i30cw	FD/FDH	ab 2008
• i30cw	GDH	ab 2012
• i30cw	PDE	ab 2017
• i40 (4-Türer)	VF	ab 2012
• i40cw	VF	ab 2011
• ix20 (5-Türer)	JC	ab 2010

## I

• ix35 (5-Türer)	EL	ab 2010
• ix35 FCEV (5-Türer)	LM	ab 2013
• ix55 (5-Türer)	EN	ab 2009
• Ioniq Hybrid (5-Türer)	AE HEV	ab 2016
• Ioniq Hybrid (5-Türer)	AE HEV	ab 2017
• Ioniq Elektro (5-Türer)	AE EV	ab 2016
• Ioniq Plug-in Hybrid (5-Türer)	AE PHEV	ab 2017

## K

• Kona (5-Türer)	OS	ab 2017
------------------	----	---------

## M

• Matrix (5-Türer)	FC/FCT	ab 2002
--------------------	--------	---------

## S

• Santa Fe (5-Türer)	SM	ab 2000
• Santa Fe (5-Türer)	CM	ab 2006
• (Grand) Santa Fe (5-Türer)	DM/NC	ab 2012
• Sonata (4-Türer)	EF	ab 1999
• Sonata (4-Türer)	EF	ab 2001
• Sonata (4-Türer)	NF	ab 2005

## T

• Terracan (5-Türer)	HP	ab 2001
• Trajet (5-Türer)	FO	ab 2000
• Tucson (5-Türer)	JM	ab 2004
• Tucson (5-Türer)	TLE	ab 2015

## V

• Veloster (4-Türer)	FS	ab 2011
----------------------	----	---------

## X

• XG (4-Türer)	XG	ab 1999
----------------	----	---------

**In den Rettungsdatenblättern ist immer die maximal mögliche Ausstattung des Fahrzeugs angegeben.**





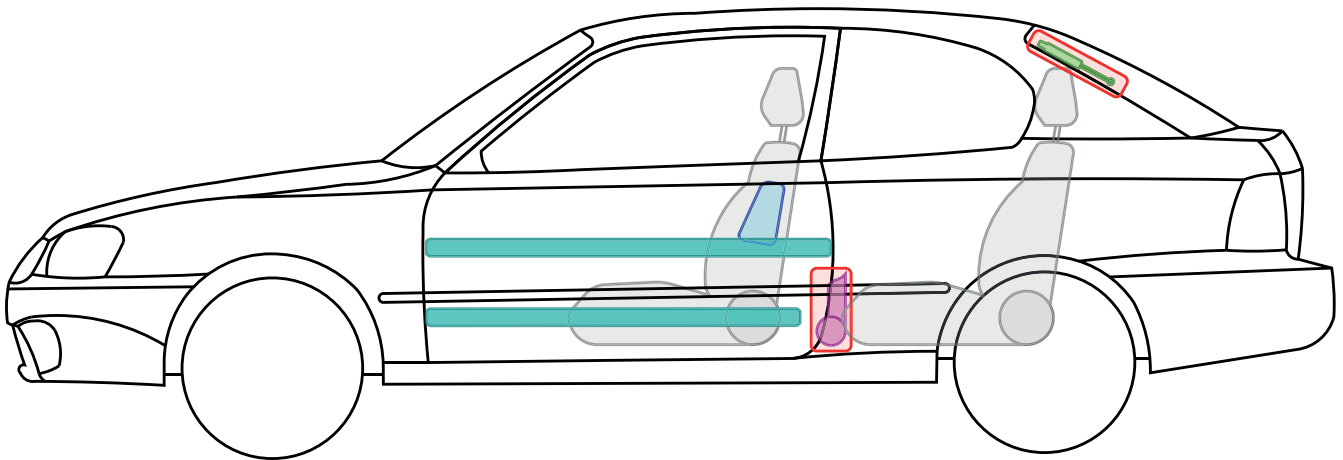
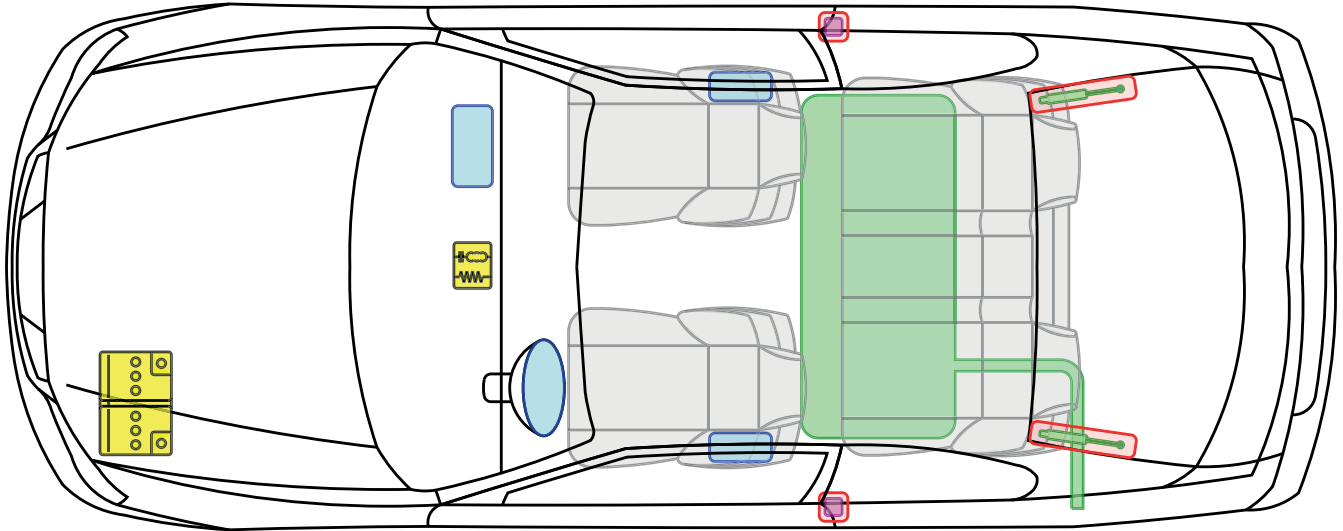

Die Erstellung der Rettungsdatenblätter erfolgte mit freundlicher Unterstützung von Moditech Rescue Solutions B.V ([www.moditech.com](http://www.moditech.com)).

Die gezeigten Fahrzeuggrafiken sind in erweiterter interaktiver Form auch in der Datenbank Crash Recovery System zu finden.

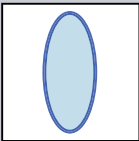
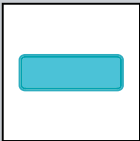

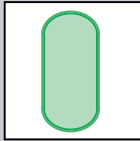
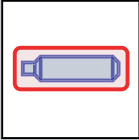
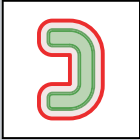
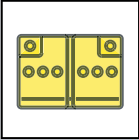

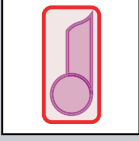
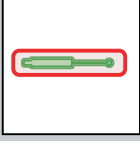
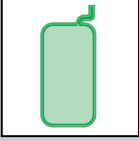

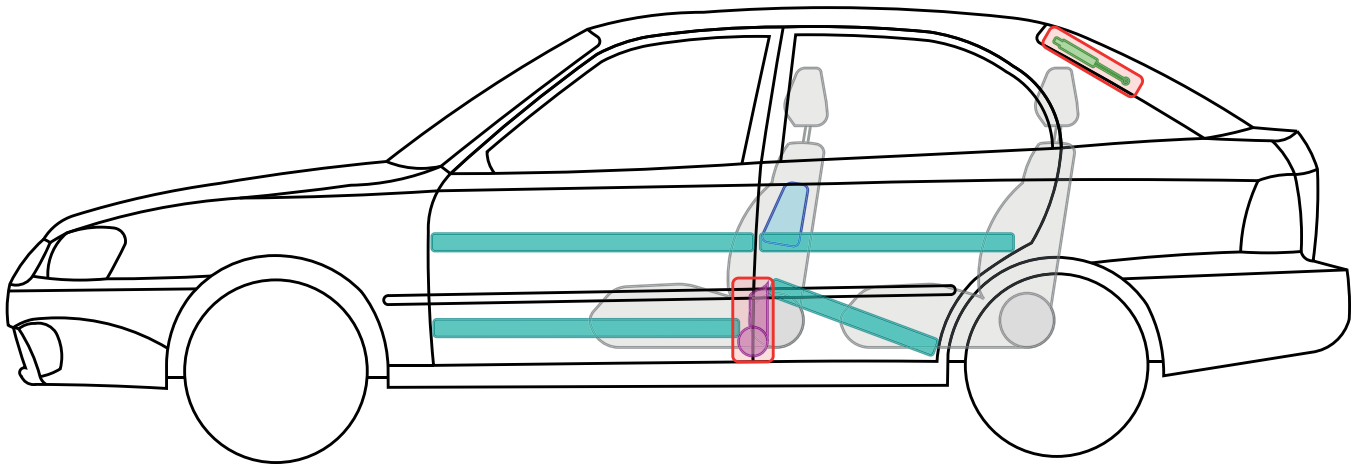
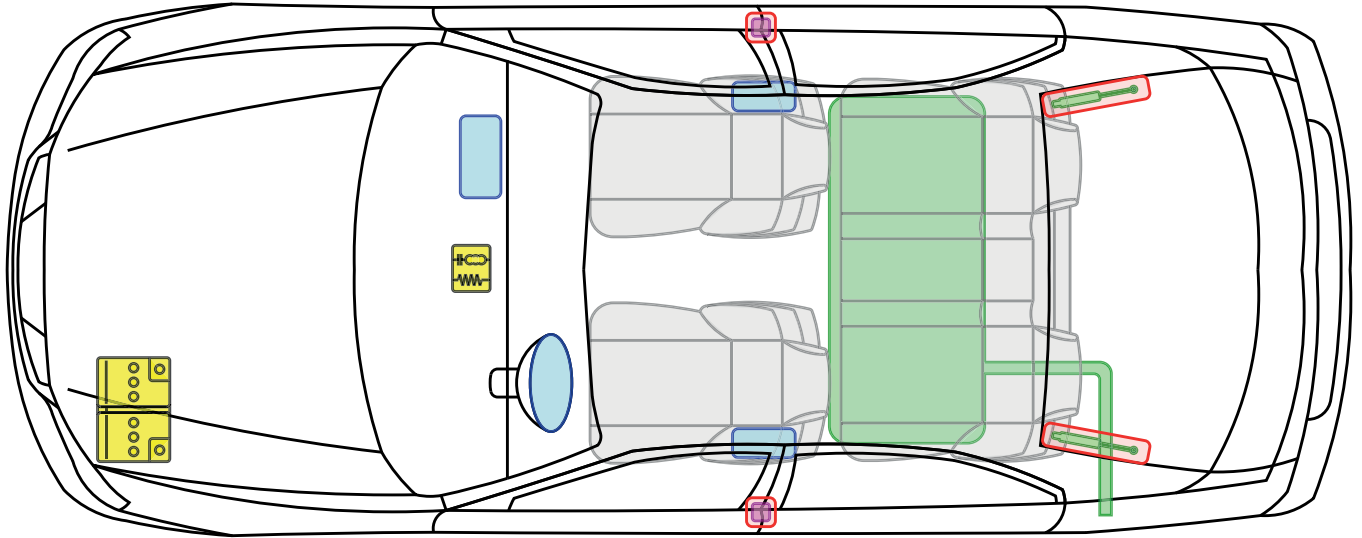

Legende

	Airbag		Karosserie- verstärkung		Steuergerät		Gastank
	Gas- generator		Überroll- schutz		12 V Batterie		Sicherheits- ventil
	Gurt- straffer		Gasdruck- dämpfer		Kraftstoff- tank		

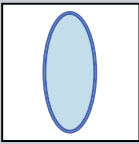
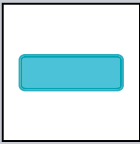
**Accent**

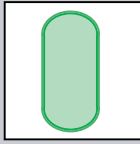
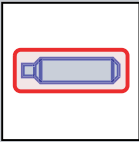
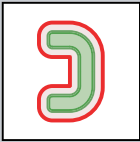
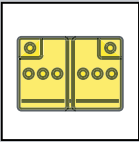

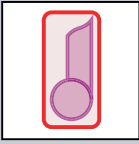
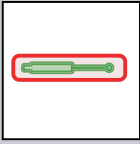

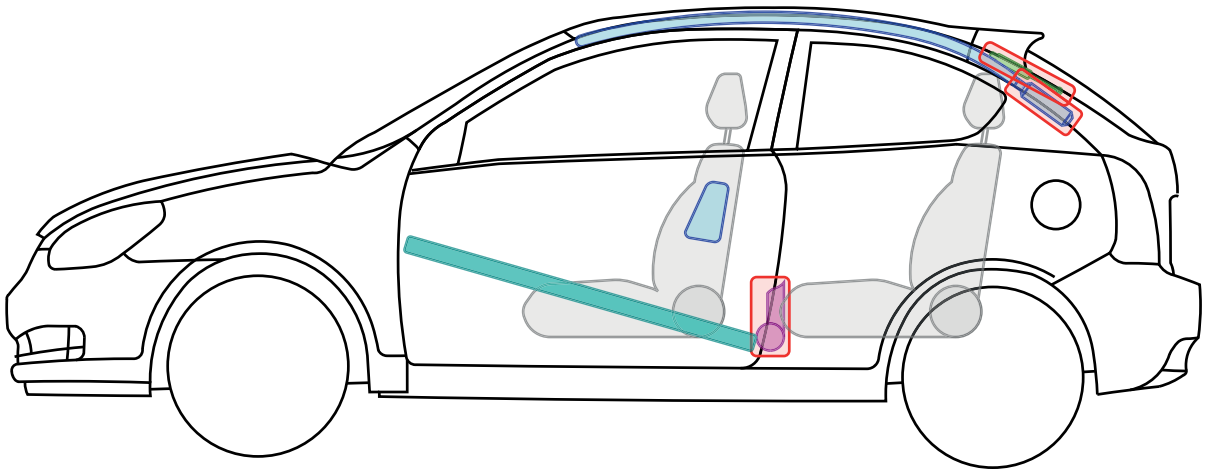
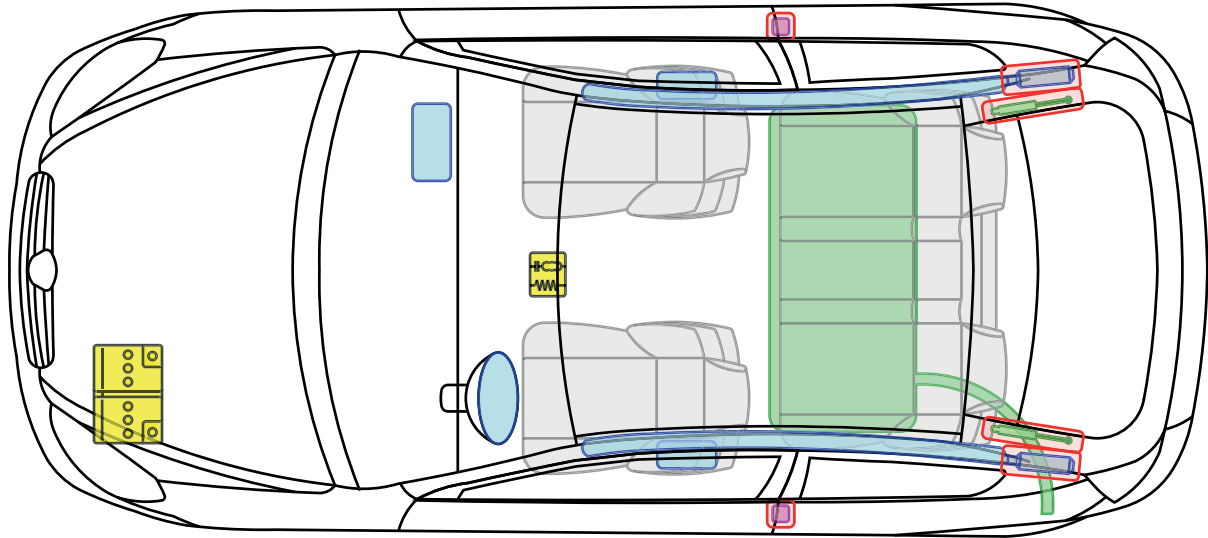

Legende

	Airbag		Karosserie- verstärkung		Steuergerät		Gastank
	Gas- generator		Überroll- schutz		12 V Batterie		Sicherheits- ventil
	Gurt- straffer		Gasdruck- dämpfer		Kraftstoff- tank		

**Accent**

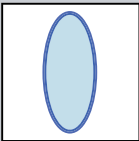
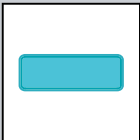

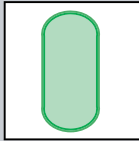
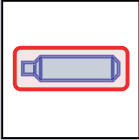
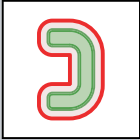
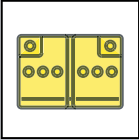

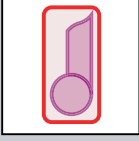
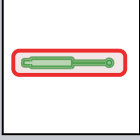
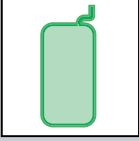

Legende

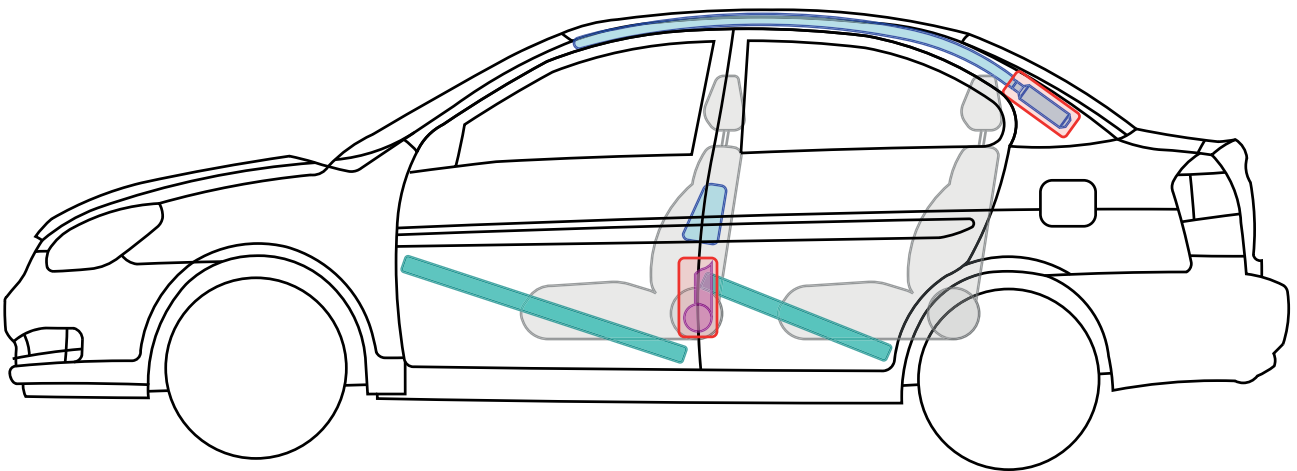
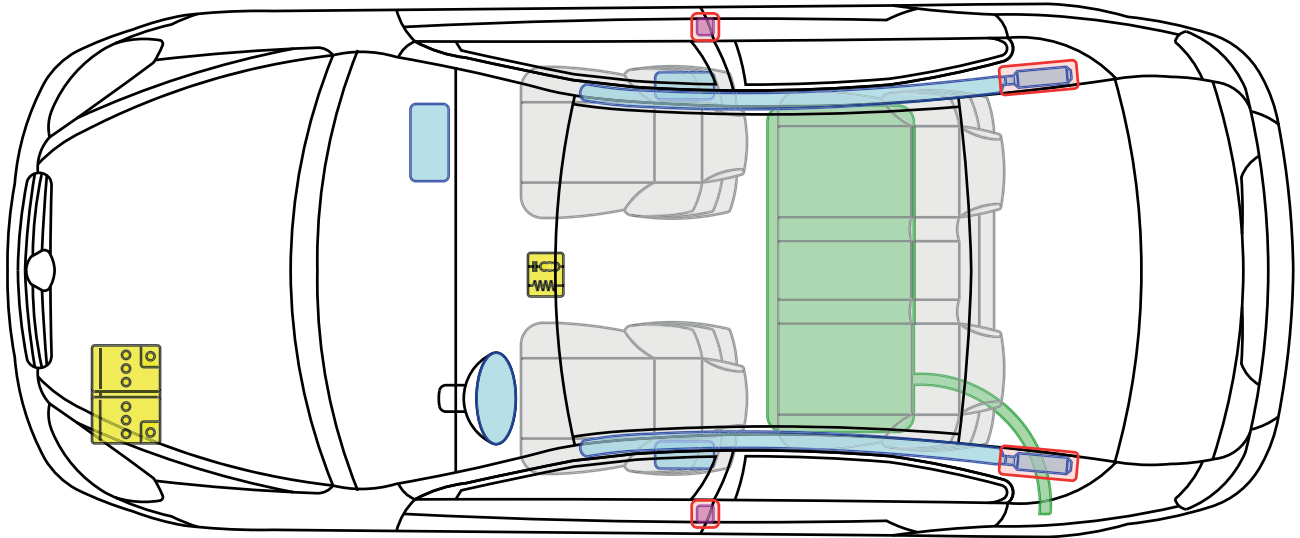
	Airbag		Karosserie- verstärkung		Steuergerät		Gastank
	Gas- generator		Überroll- schutz		12 V Batterie		Sicherheits- ventil
	Gurt- straffer		Gasdruck- dämpfer		Kraftstoff- tank		

**Accent**

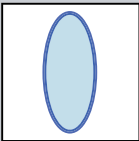
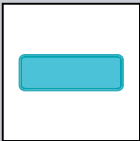

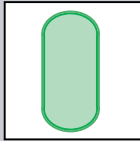
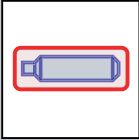
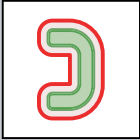
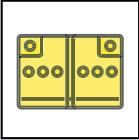
Legende

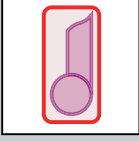
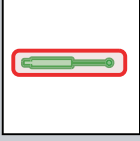
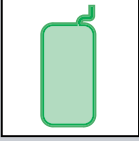
	Airbag		Karosserie- verstärkung		Steuergerät		Gastank
	Gas- generator		Überroll- schutz		12 V Batterie		Sicherheits- ventil
	Gurt- straffer		Gasdruck- dämpfer		Kraftstoff- tank		

**Accent**







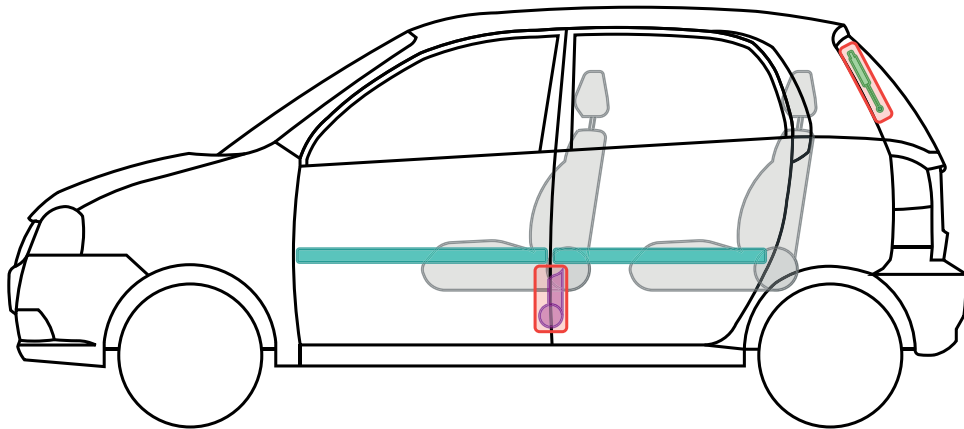
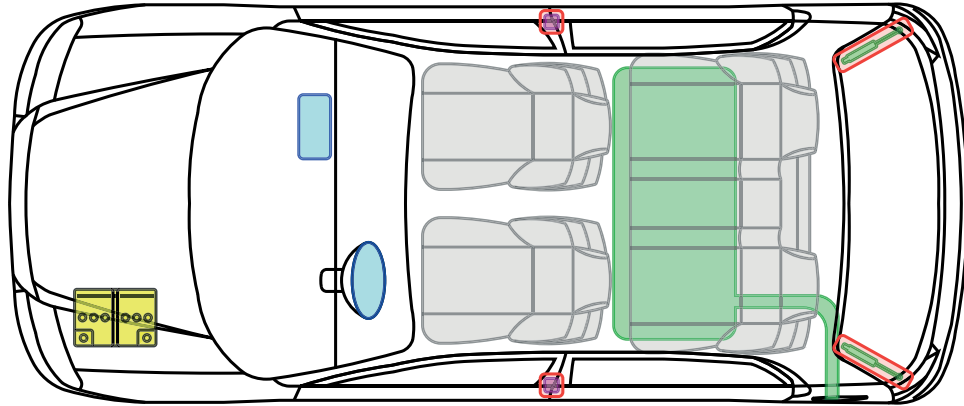

# Atos, 5-Türer

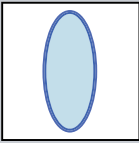
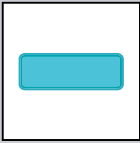
(Typ MX, MXL, MXI, 1998-2008)

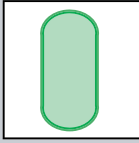
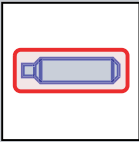
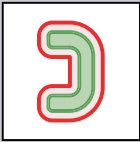
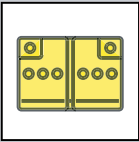

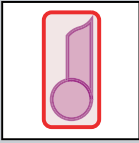
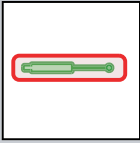
## Legende



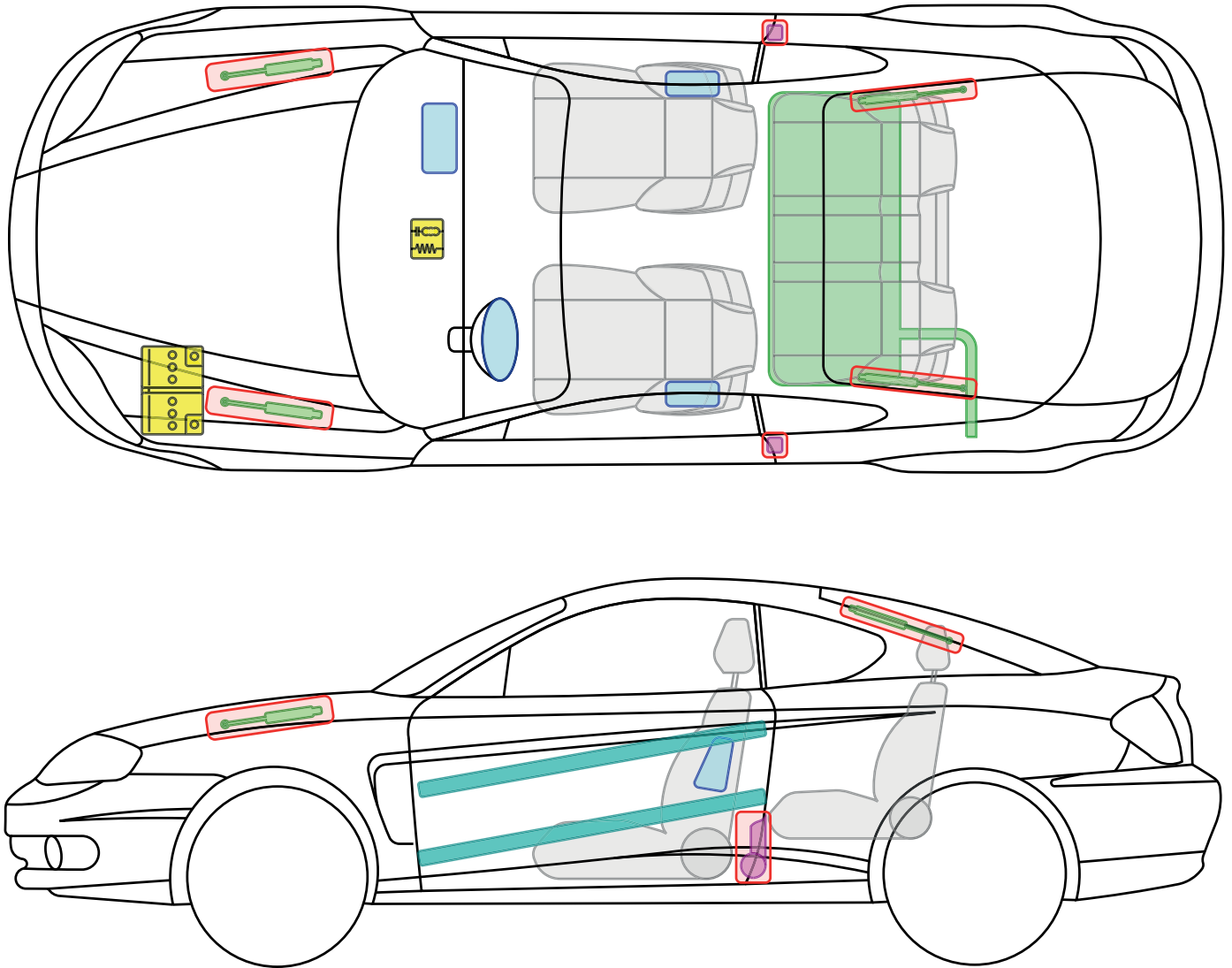

	Airbag		Karosserie- verstärkung		Steuergerät		Gastank
	Gas- generator		Überroll- schutz		12 V Batterie		Sicherheits- ventil
	Gurt- straffer		Gasdruck- dämpfer		Kraftstoff- tank		

**Atos**



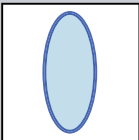
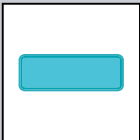

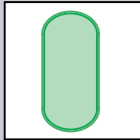
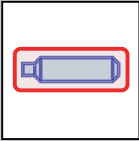
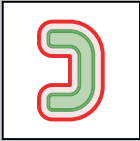
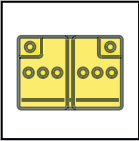

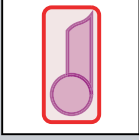
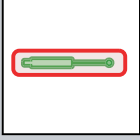
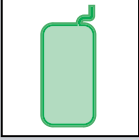

**Legende**

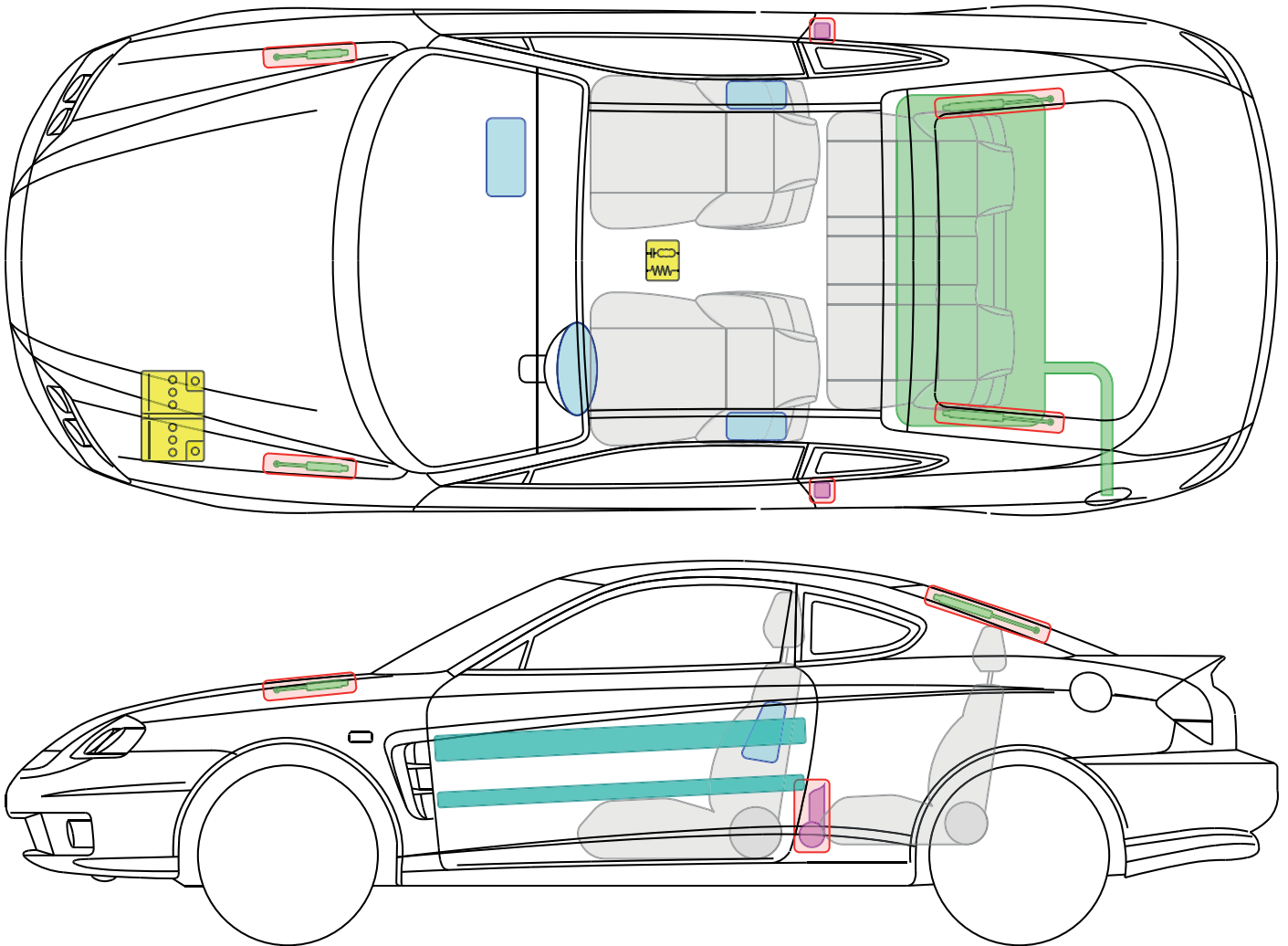
	Airbag		Karosserie- verstärkung		Steuergerät		Gastank
	Gas- generator		Überroll- schutz		12 V Batterie		Sicherheits- ventil
	Gurt- straffer		Gasdruck- dämpfer		Kraftstoff- tank		

**Coupe**

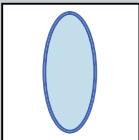
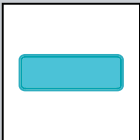

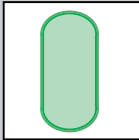
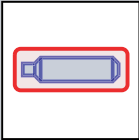
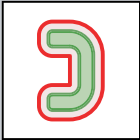
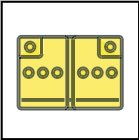
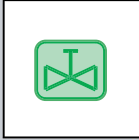
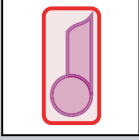
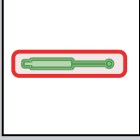



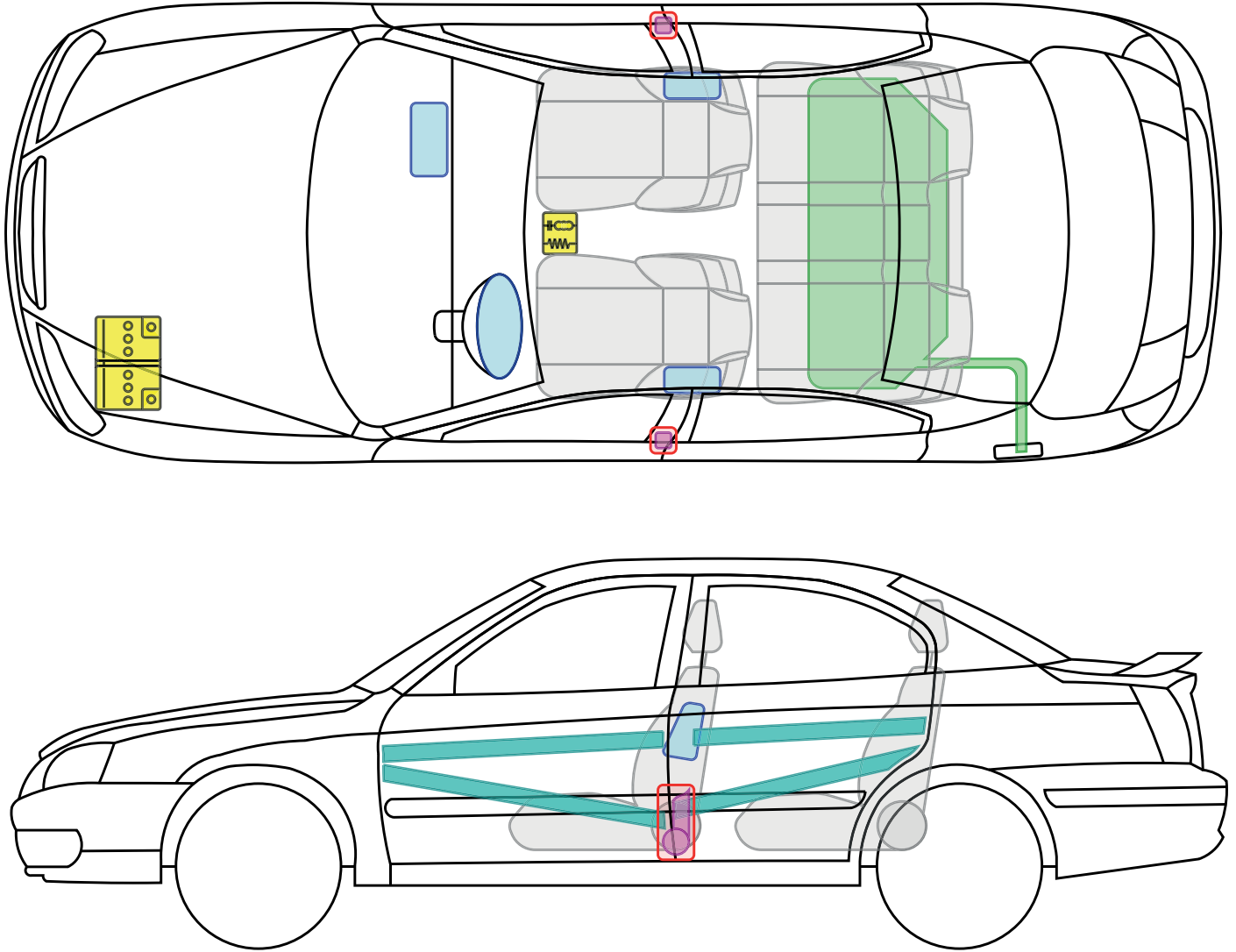

**Legende**

	Airbag		Karosserie- verstärkung		Steuergerät		Gastank
	Gas- generator		Überroll- schutz		12 V Batterie		Sicherheits- ventil
	Gurt- straffer		Gasdruck- dämpfer		Kraftstoff- tank		

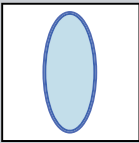
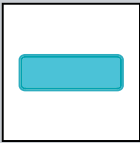
**Coupe**

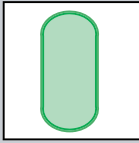
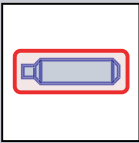
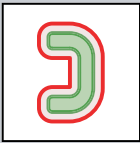
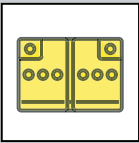

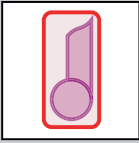
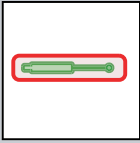

Legende

	Airbag		Karosserie- verstärkung		Steuergerät		Gastank
	Gas- generator		Überschallschutz		12 V Batterie		Sicherheits- ventil
	Gurt- straffer		Gasdruck- dämpfer		Kraftstoff- tank		

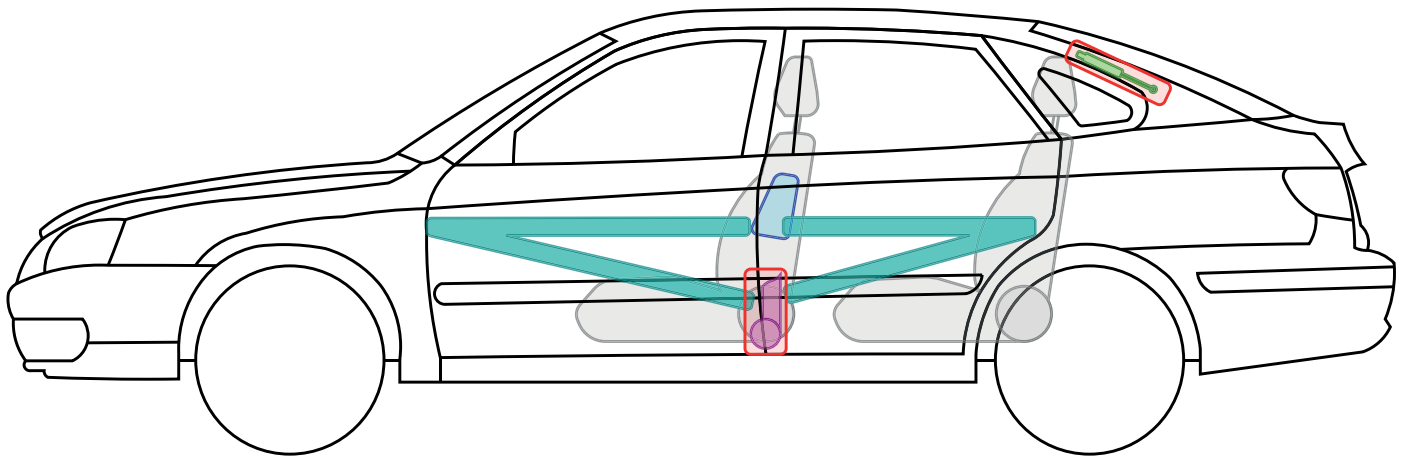
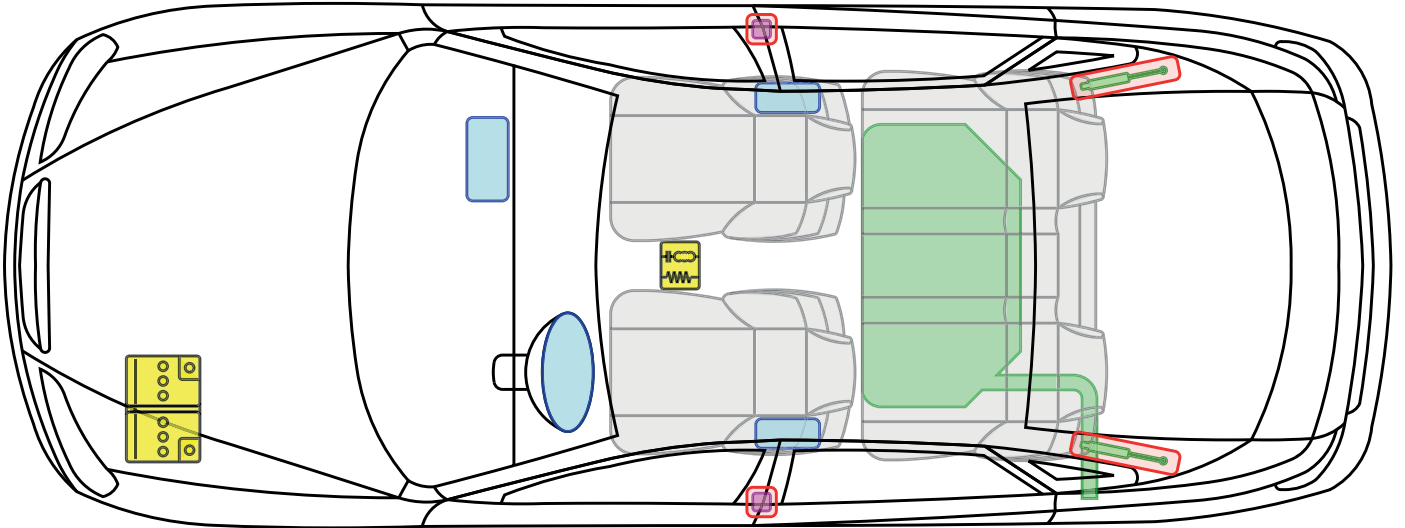
**Elantra**



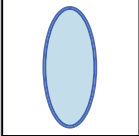
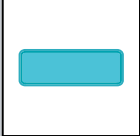
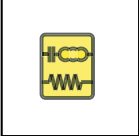
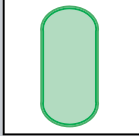
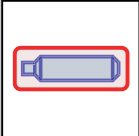
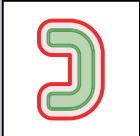
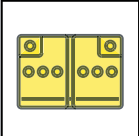
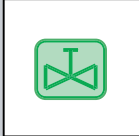
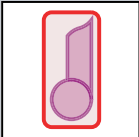
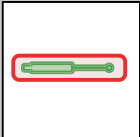



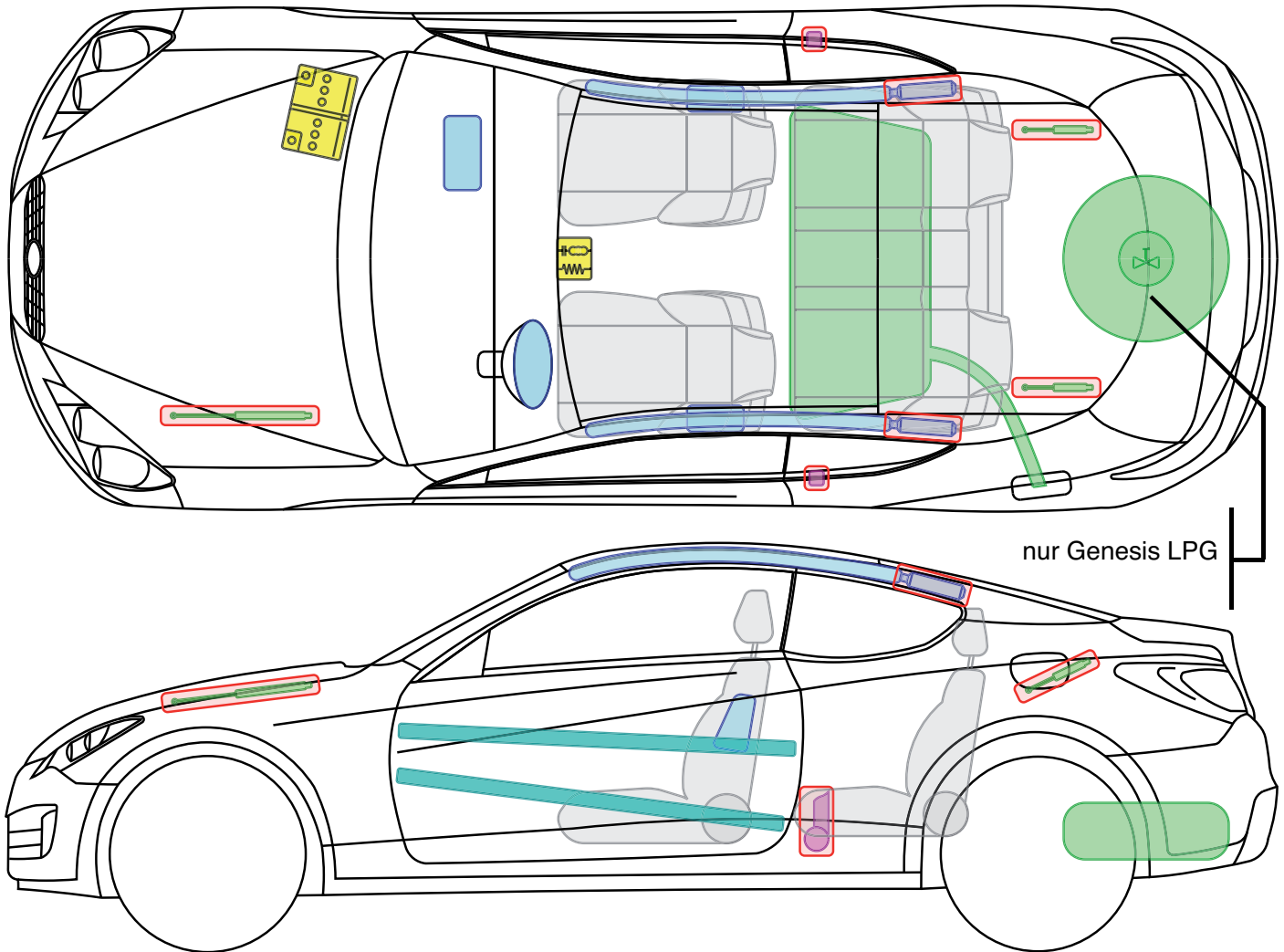

Legende

	Airbag		Karosserie- verstärkung		Steuergerät		Gastank
	Gas- generator		Überroll- schutz		12 V Batterie		Sicherheits- ventil
	Gurt- straffer		Gasdruck- dämpfer		Kraftstoff- tank		

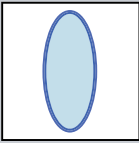
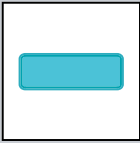
**Elantra**

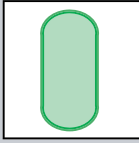
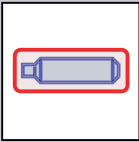
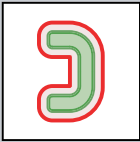
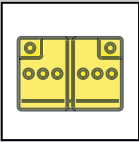

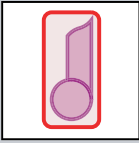
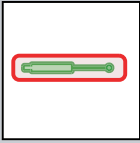



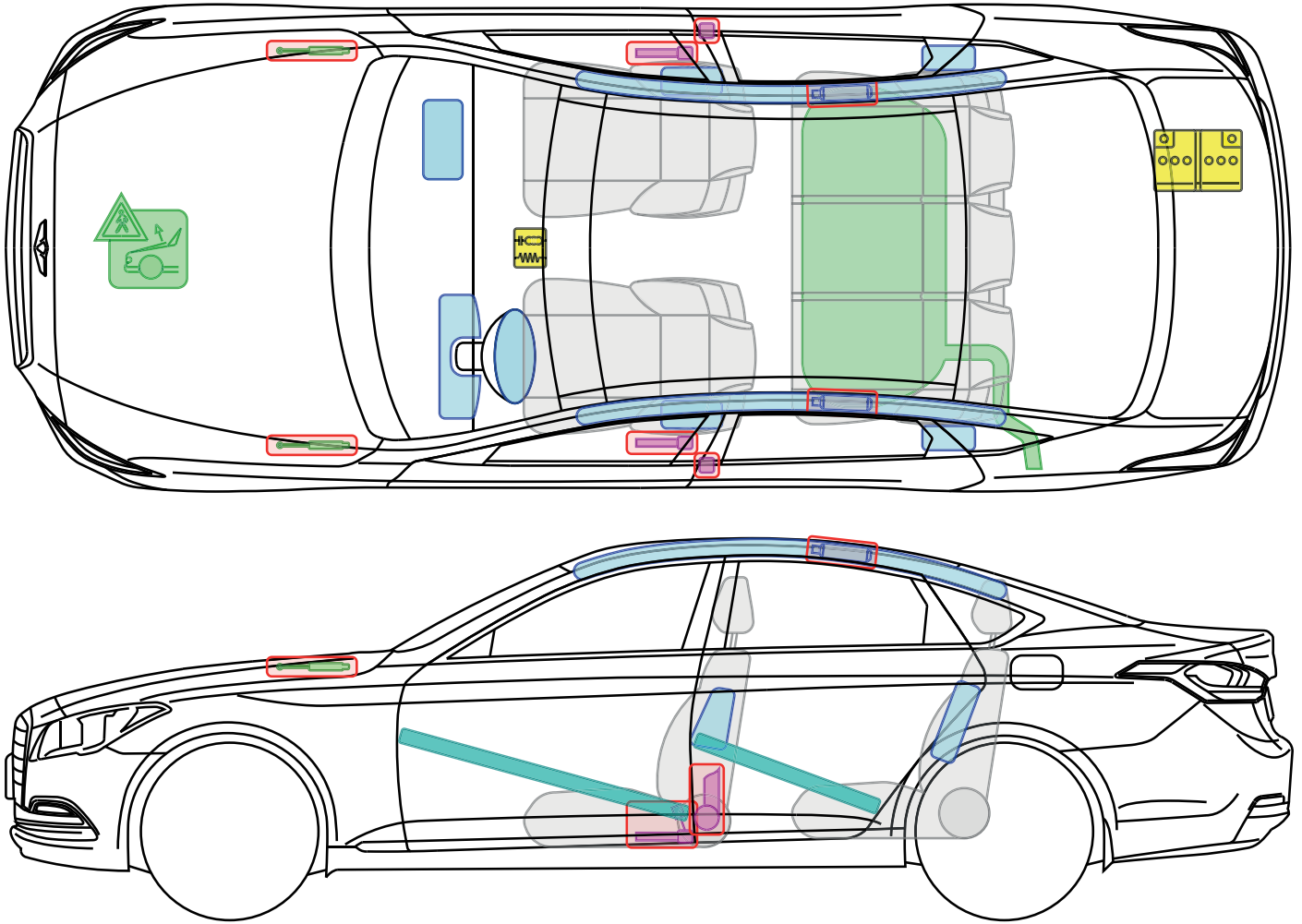

**Legende**

	Airbag		Karosserie- verstärkung		Steuergerät		Gastank
	Gas- generator		Überroll- schutz		12 V Batterie		Sicherheits- ventil
	Gurt- straffer		Gasdruck- dämpfer		Kraftstoff- tank		

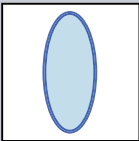
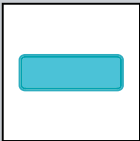
**Genesis Coupe**

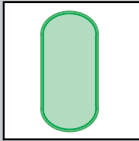
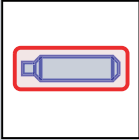
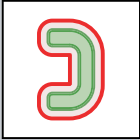
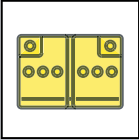

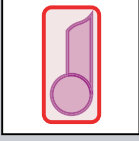
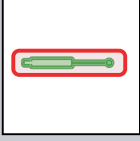
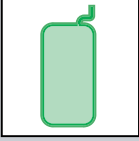

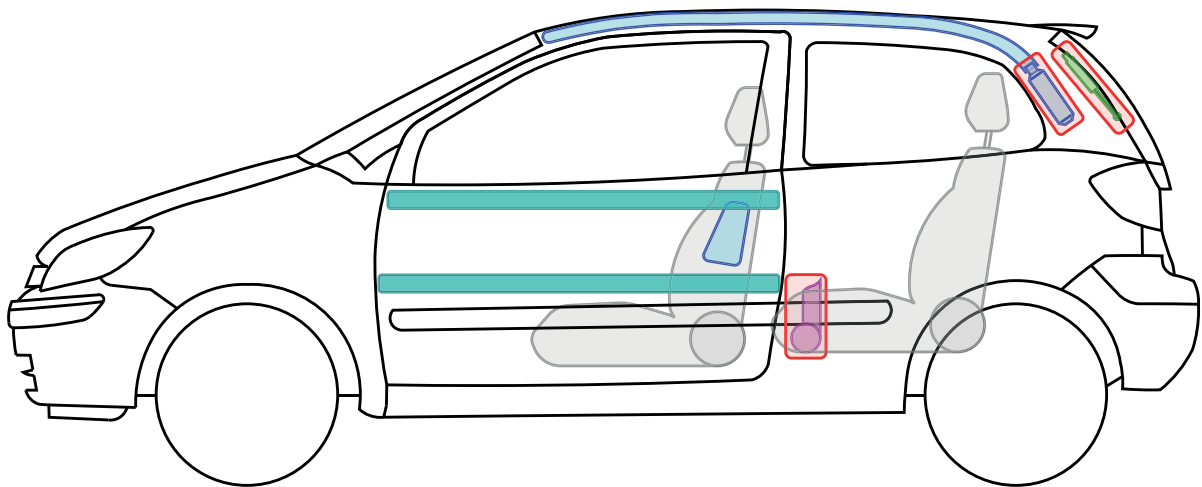
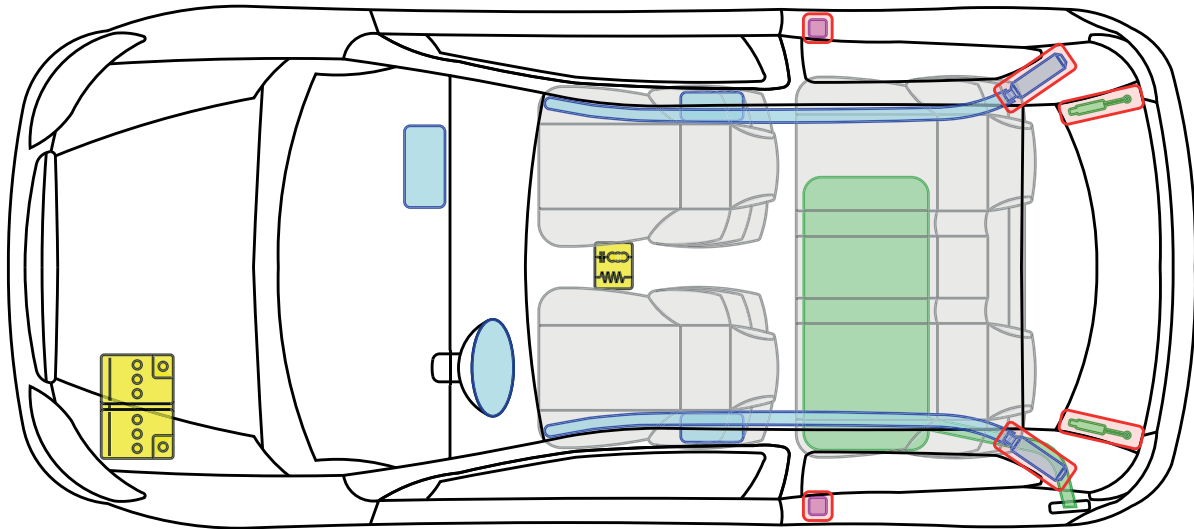

**Legende**

	Airbag		Karosserie- verstärkung		Steuergerät		Gastank
	Gas- generator		Überroll- schutz		12 V Batterie		Sicherheits- ventil
	Gurt- straffer		Gasdruck- dämpfer		Kraftstoff- tank		Fußgänger- schutzsystem

**Genesis**

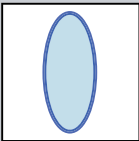
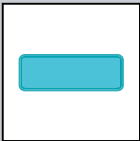

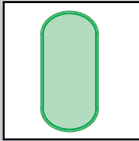
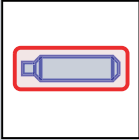
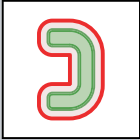
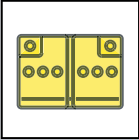

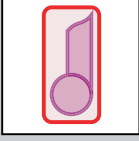
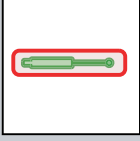
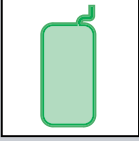

Legende

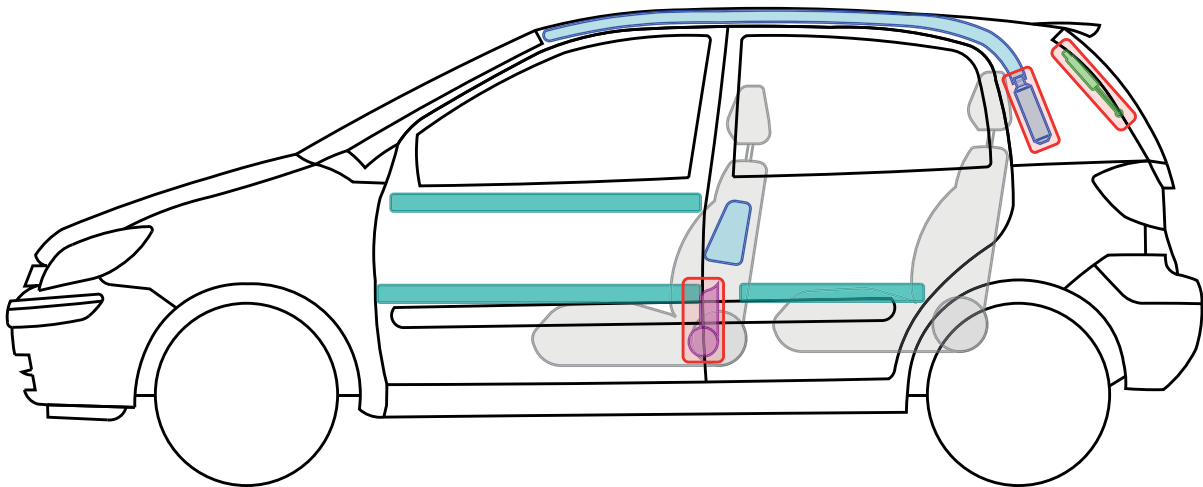
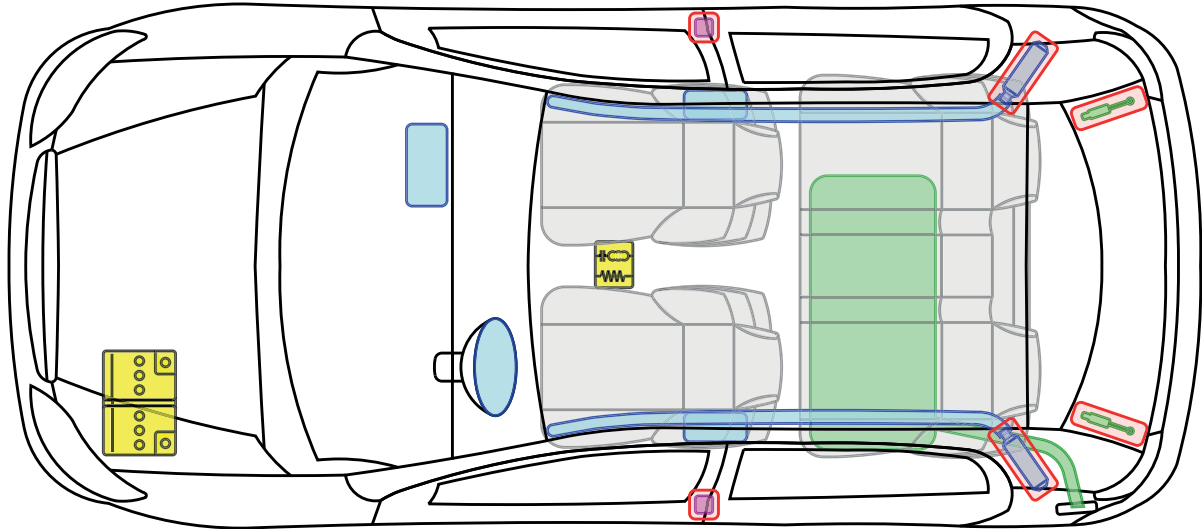
	Airbag		Karosserie- verstärkung		Steuergerät		Gastank
	Gas- generator		Überroll- schutz		12 V Batterie		Sicherheits- ventil
	Gurt- straffer		Gasdruck- dämpfer		Kraftstoff- tank		

**Getz**

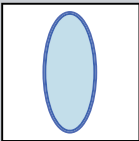
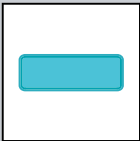

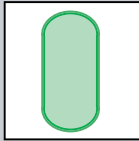
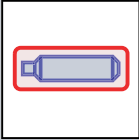
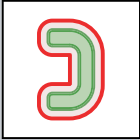
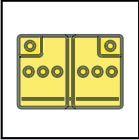
Legende

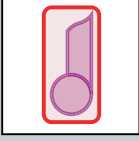
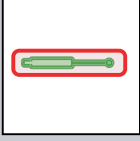
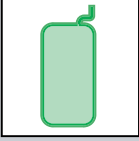
	Airbag		Karosserie- verstärkung		Steuergerät		Gastank
	Gas- generator		Überroll- schutz		12 V Batterie		Sicherheits- ventil
	Gurt- straffer		Gasdruck- dämpfer		Kraftstoff- tank		



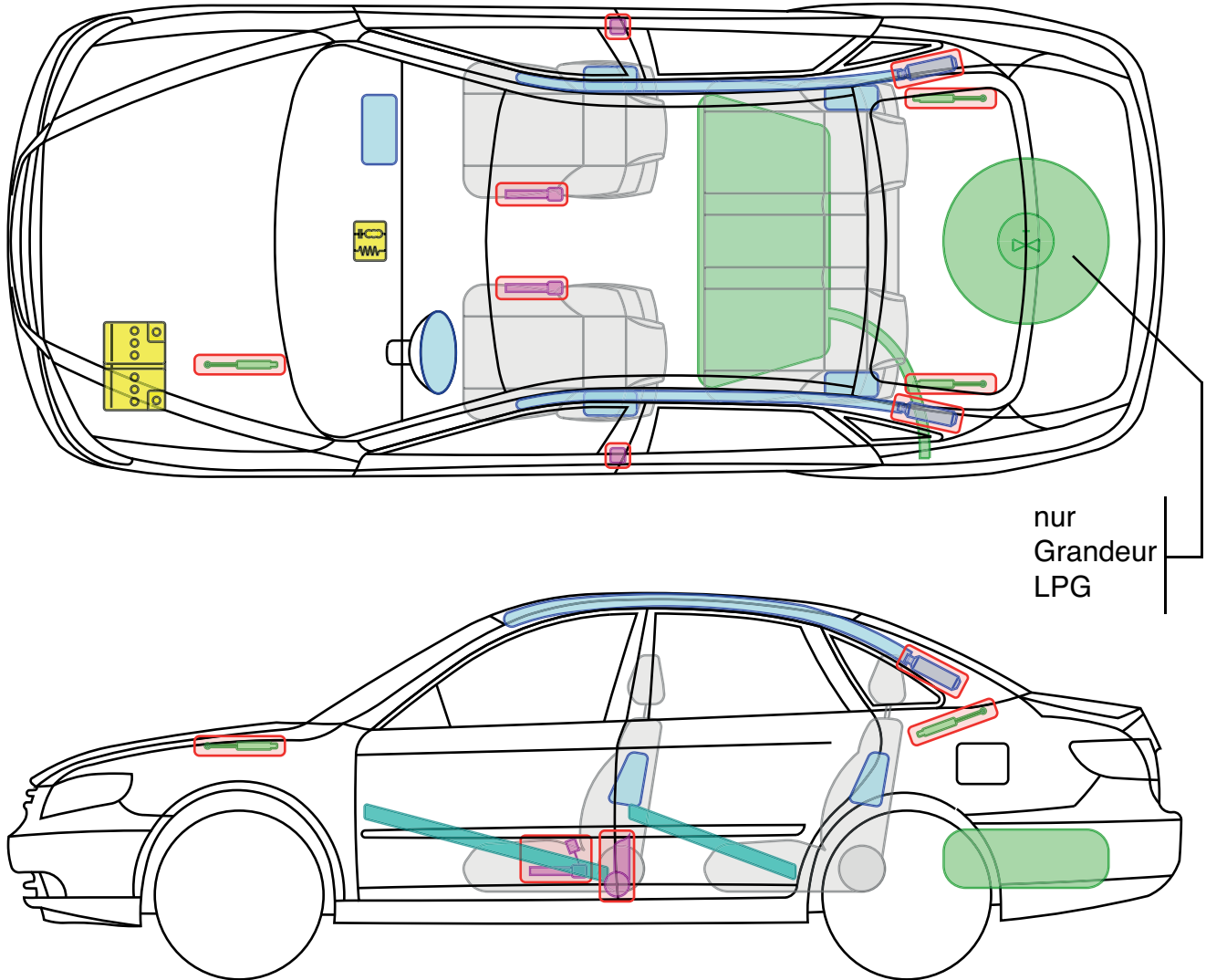

**Getz**



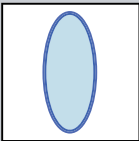
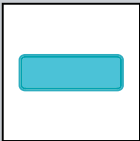

nur  
Grandeur  
LPG

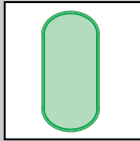
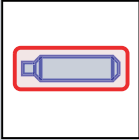
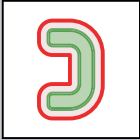
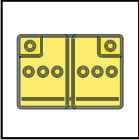

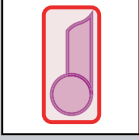
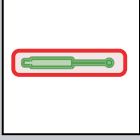
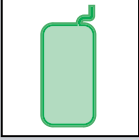

**Legende**

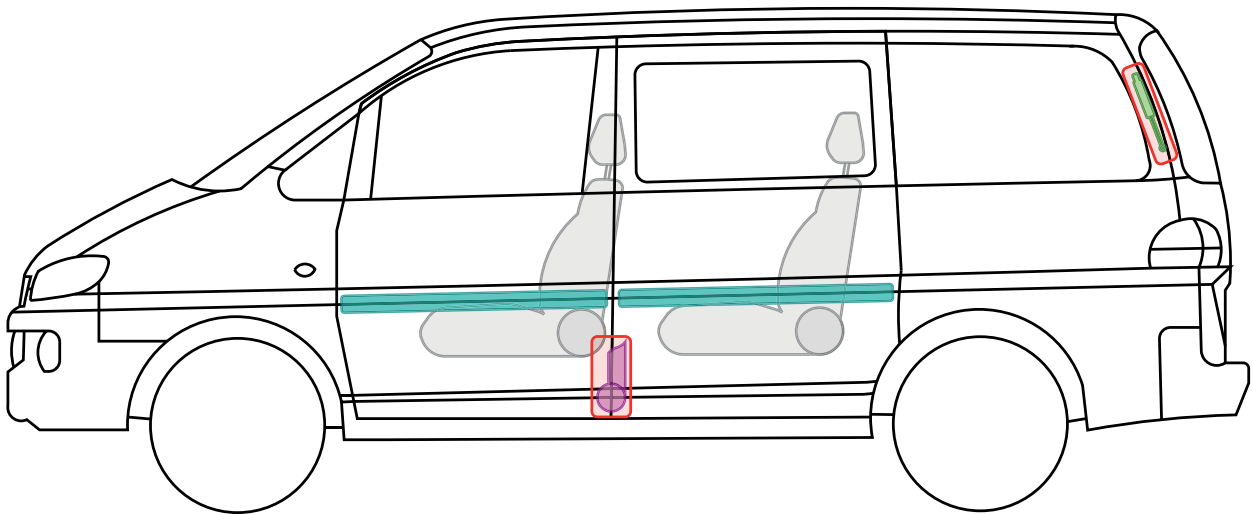
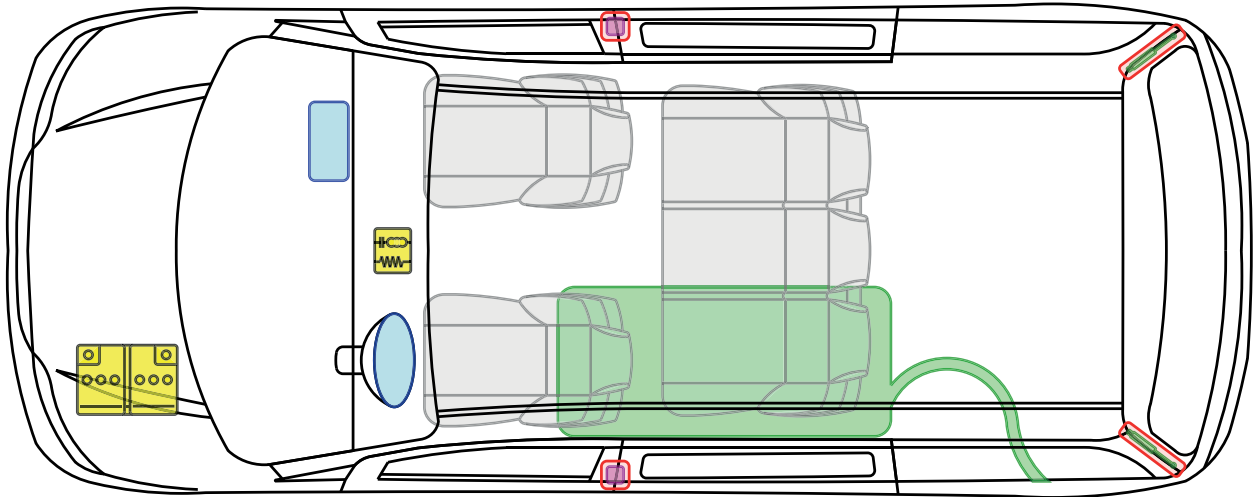
	Airbag		Karosserie- verstärkung		Steuergerät		Gastank
	Gas- generator		Überroll- schutz		12 V Batterie		Sicherheits- ventil
	Gurt- straffer		Gasdruck- dämpfer		Kraftstoff- tank		

**Grandeur**

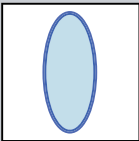
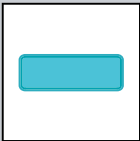

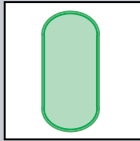
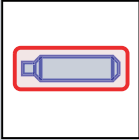
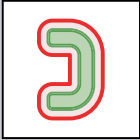
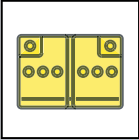

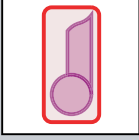
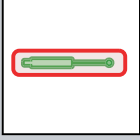
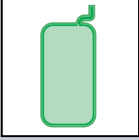

Legende

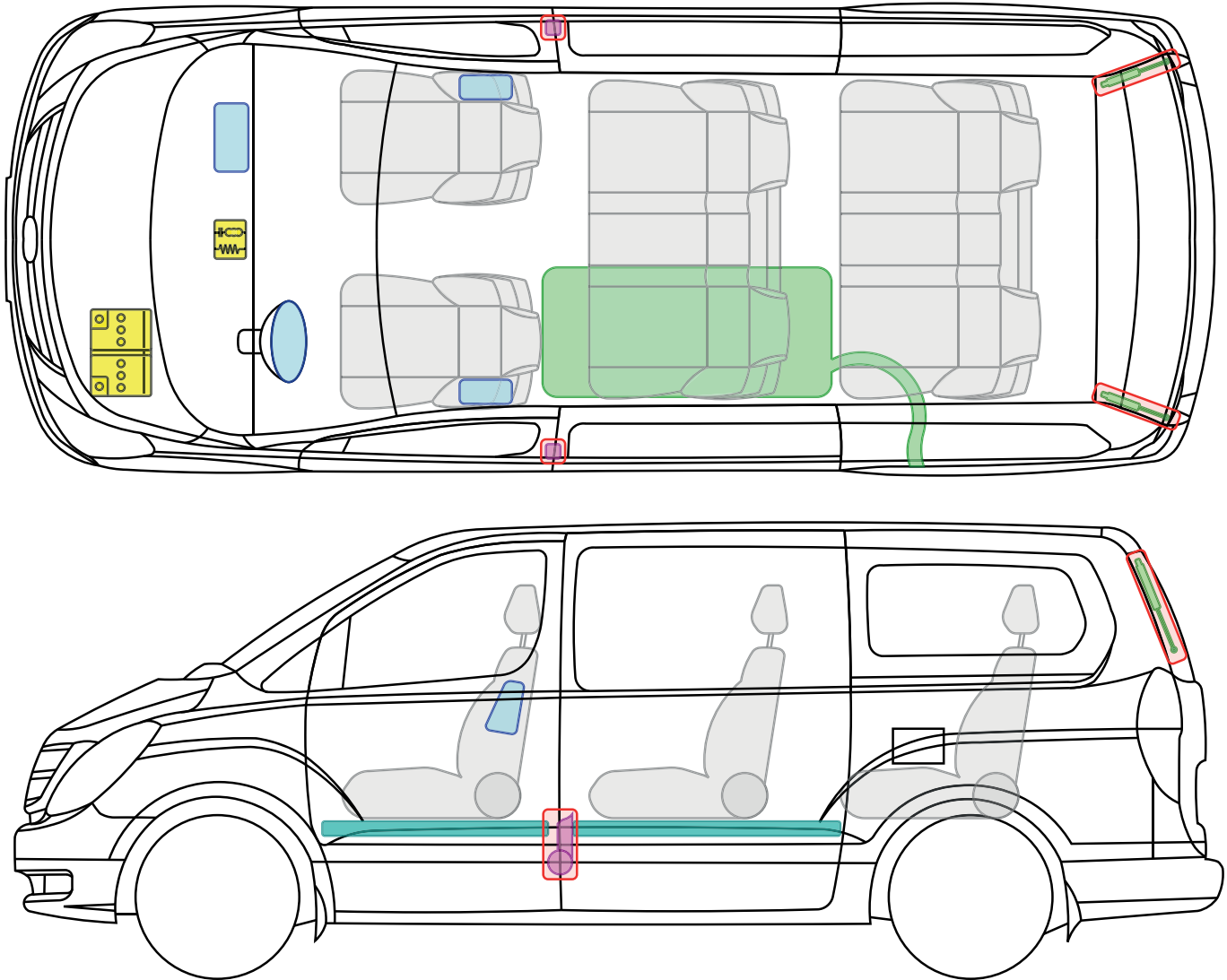
	Airbag		Karosserie- verstärkung		Steuergerät		Gastank
	Gas- generator		Überroll- schutz		12 V Batterie		Sicherheits- ventil
	Gurt- straffer		Gasdruck- dämpfer		Kraftstoff- tank		

**H-1**

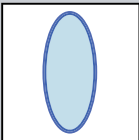
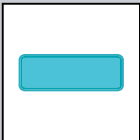

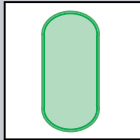
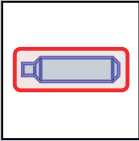
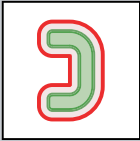
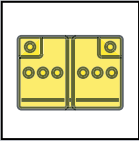

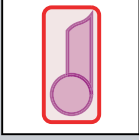
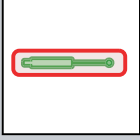
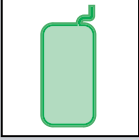

Legende

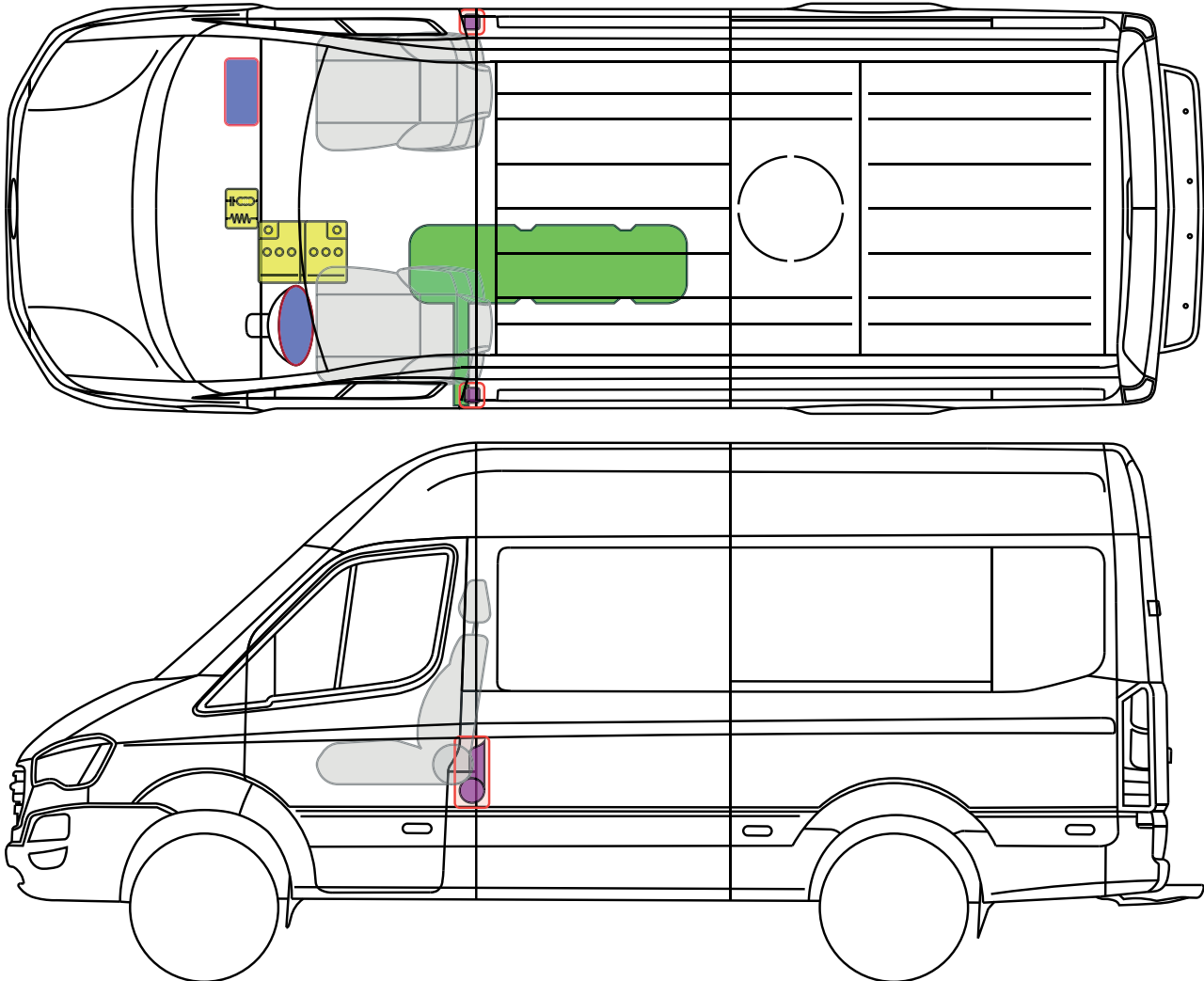
	Airbag		Karosserie- verstärkung		Steuergerät		Gastank
	Gas- generator		Überroll- schutz		12 V Batterie		Sicherheits- ventil
	Gurt- straffer		Gasdruck- dämpfer		Kraftstoff- tank		

**H-1**

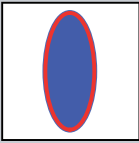
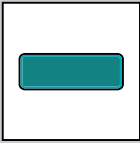
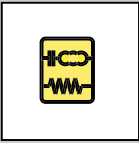
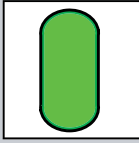
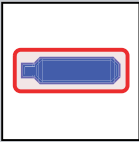

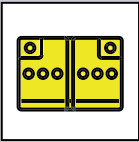
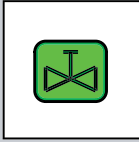
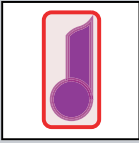
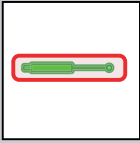

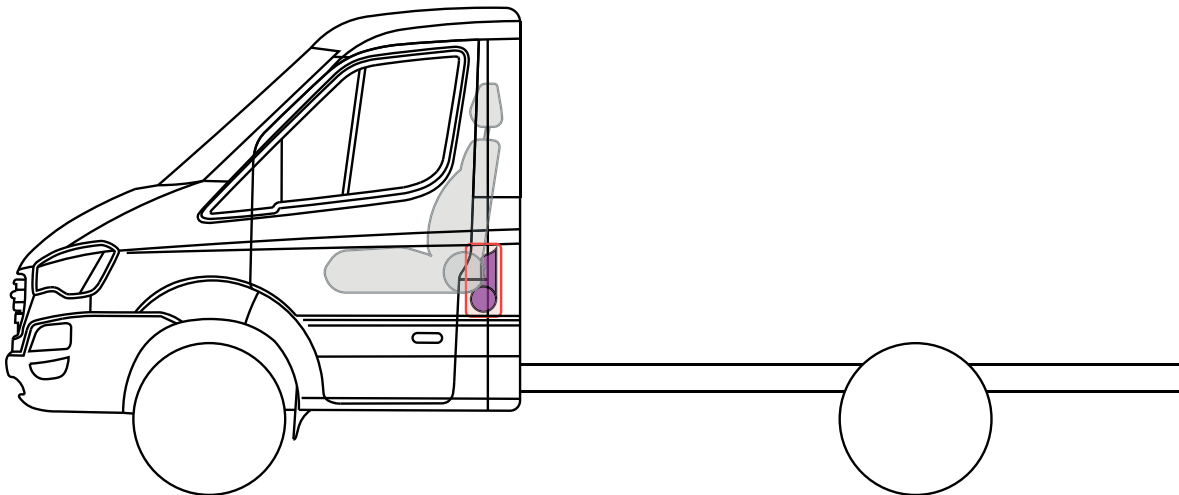
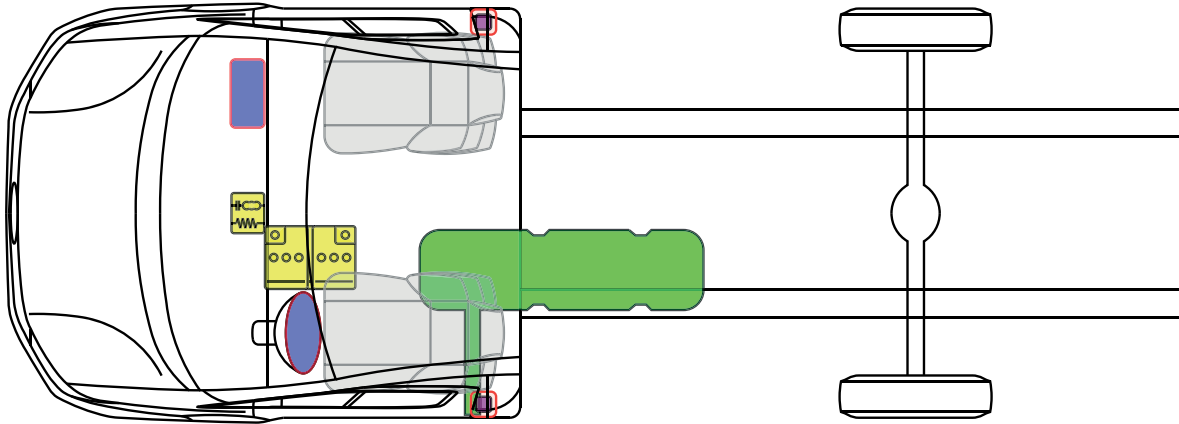

Legende

	Airbag		Karosserie- verstärkung		Steuergerät		Gastank
	Gas- generator		Überroll- schutz		12 V Batterie		Sicherheits- ventil
	Gurt- straffer		Gasdruck- dämpfer		Kraftstoff- tank		

**H-350**

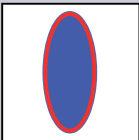
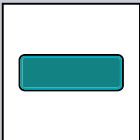
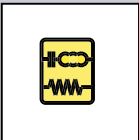
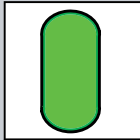
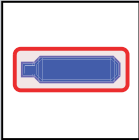

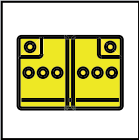
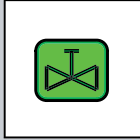
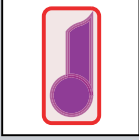
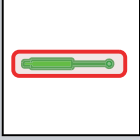

Legende

	Airbag		Karosserie- verstärkung		Steuergerät		Gastank
	Gas- generator		Überroll- schutz		12 V Batterie		Sicherheits- ventil
	Gurt- straffer		Gasdruck- dämpfer		Kraftstoff- tank		

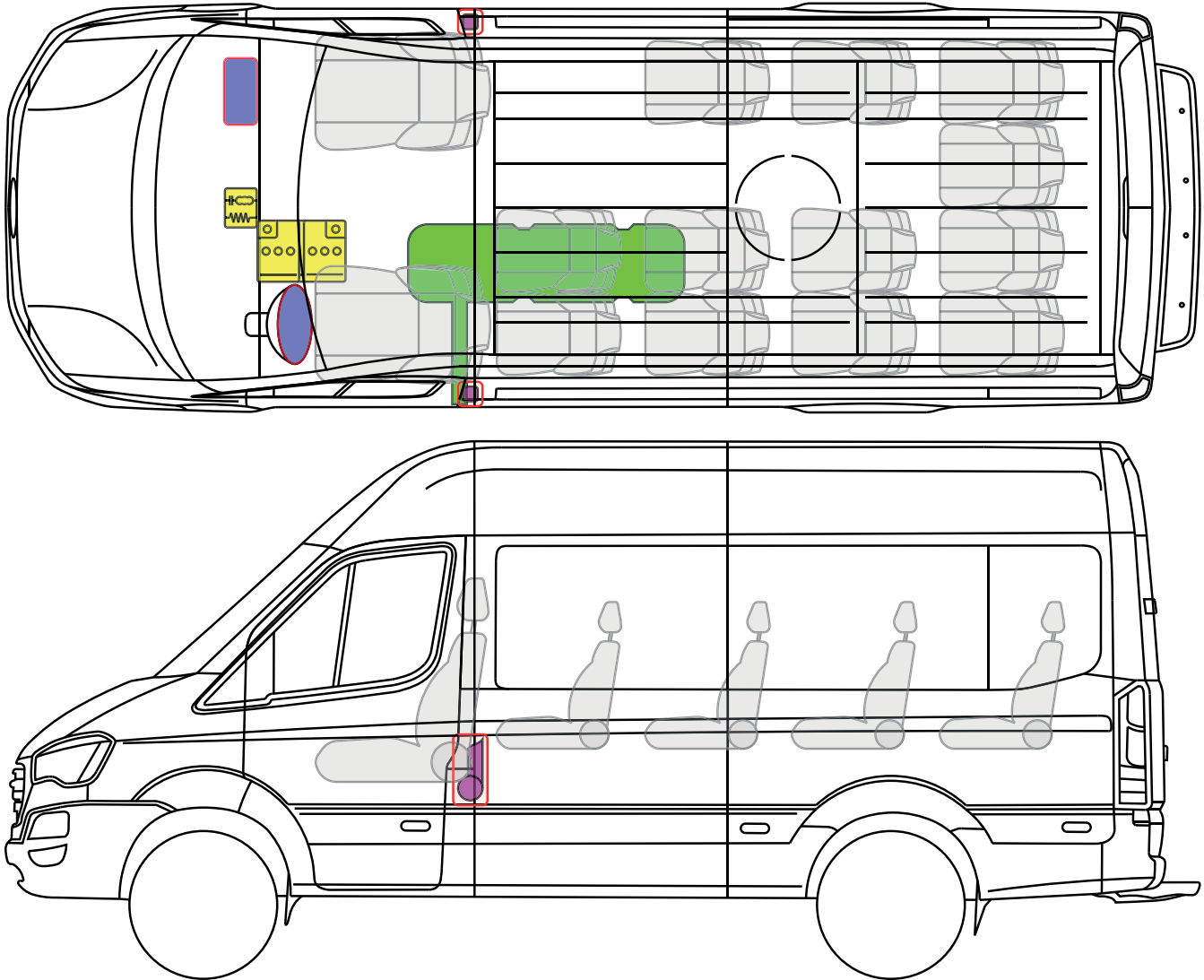
**H-350**



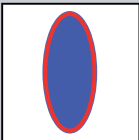
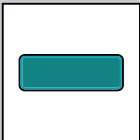
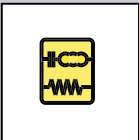
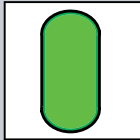
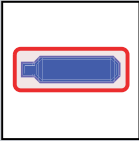

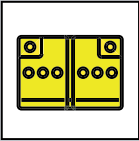
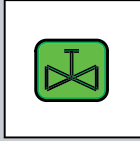
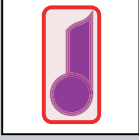
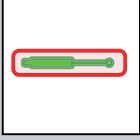
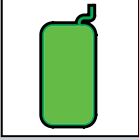

Legende

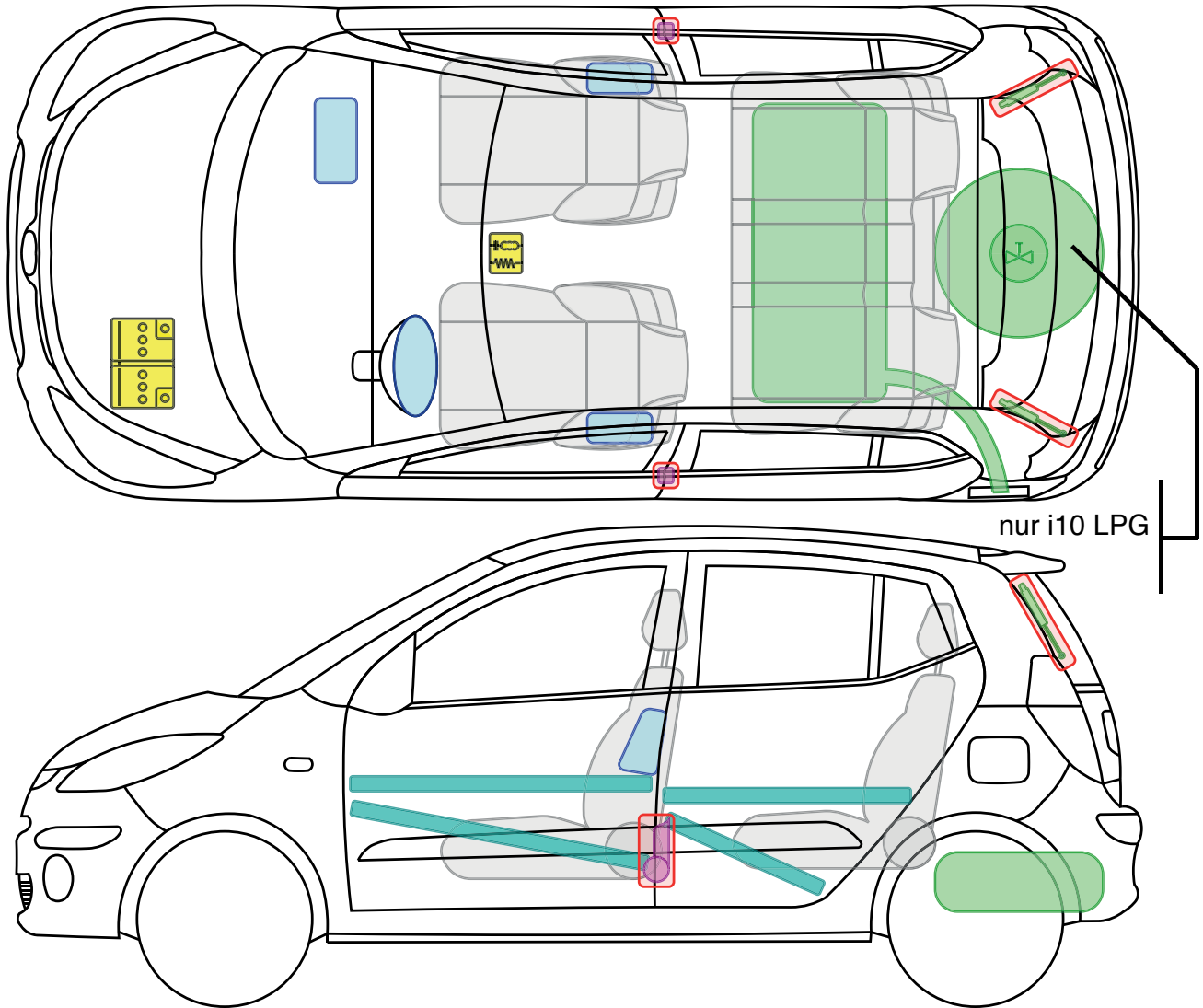
	Airbag		Karosserie- verstärkung		Steuergerät		Gastank
	Gas- generator		Überroll- schutz		12 V Batterie		Sicherheits- ventil
	Gurt- straffer		Gasdruck- dämpfer		Kraftstoff- tank		

**H-350**

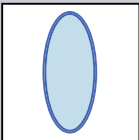
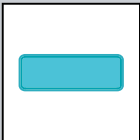

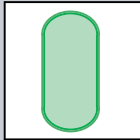
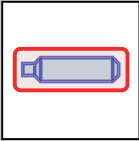
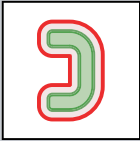
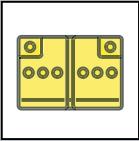

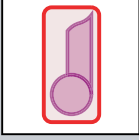
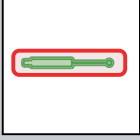
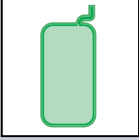

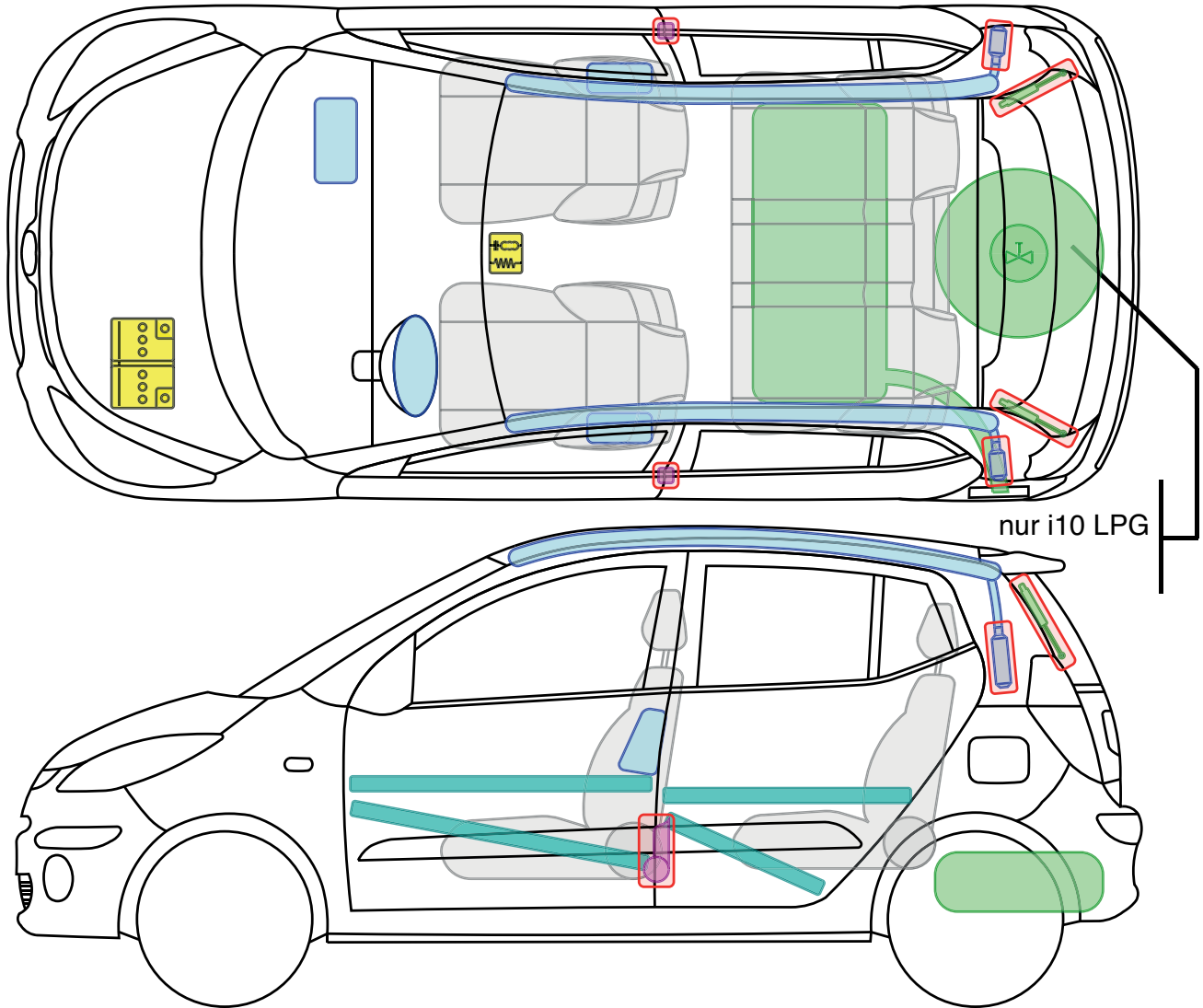

**Legende**

	Airbag		Karosserie- verstärkung		Steuergerät		Gastank
	Gas- generator		Überroll- schutz		12 V Batterie		Sicherheits- ventil
	Gurt- straffer		Gasdruck- dämpfer		Kraftstoff- tank		

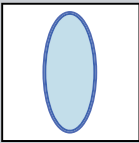
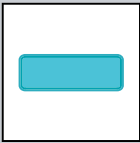
**i10**

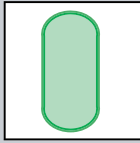
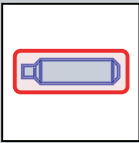
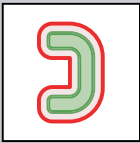
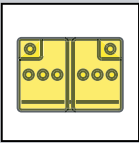

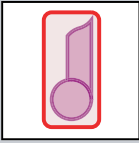
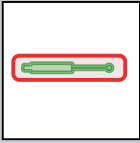
**Legende**



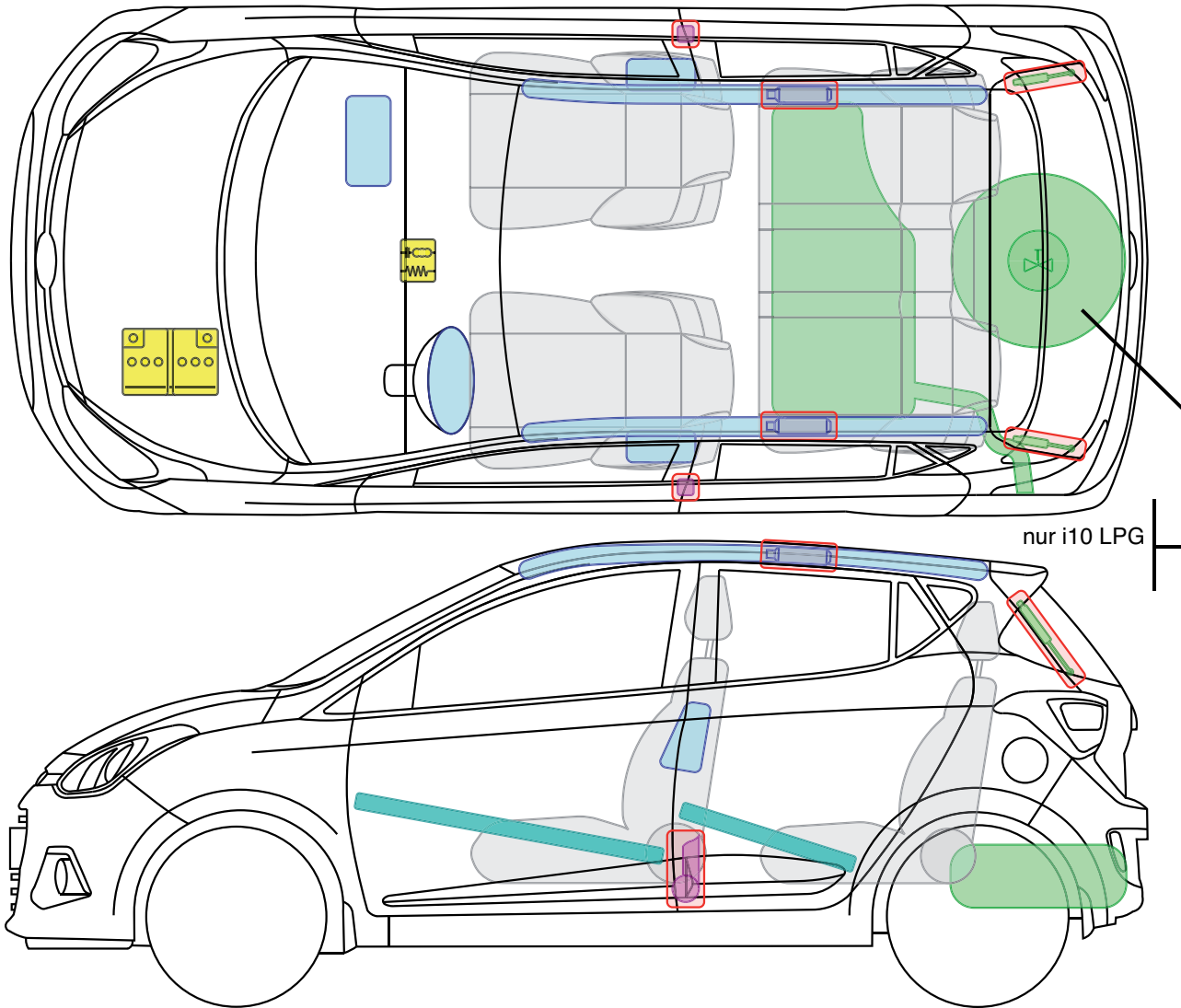

	Airbag		Karosserie- verstärkung		Steuergerät		Gastank
	Gas- generator		Überroll- schutz		12 V Batterie		Sicherheits- ventil
	Gurt- straffer		Gasdruck- dämpfer		Kraftstoff- tank		

**i10**



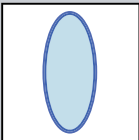
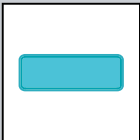

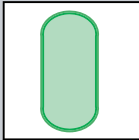
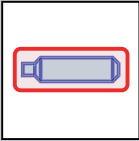
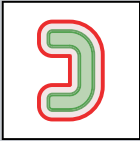
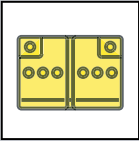

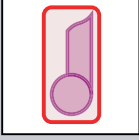
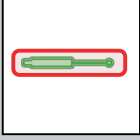
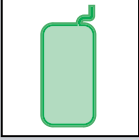

**Legende**

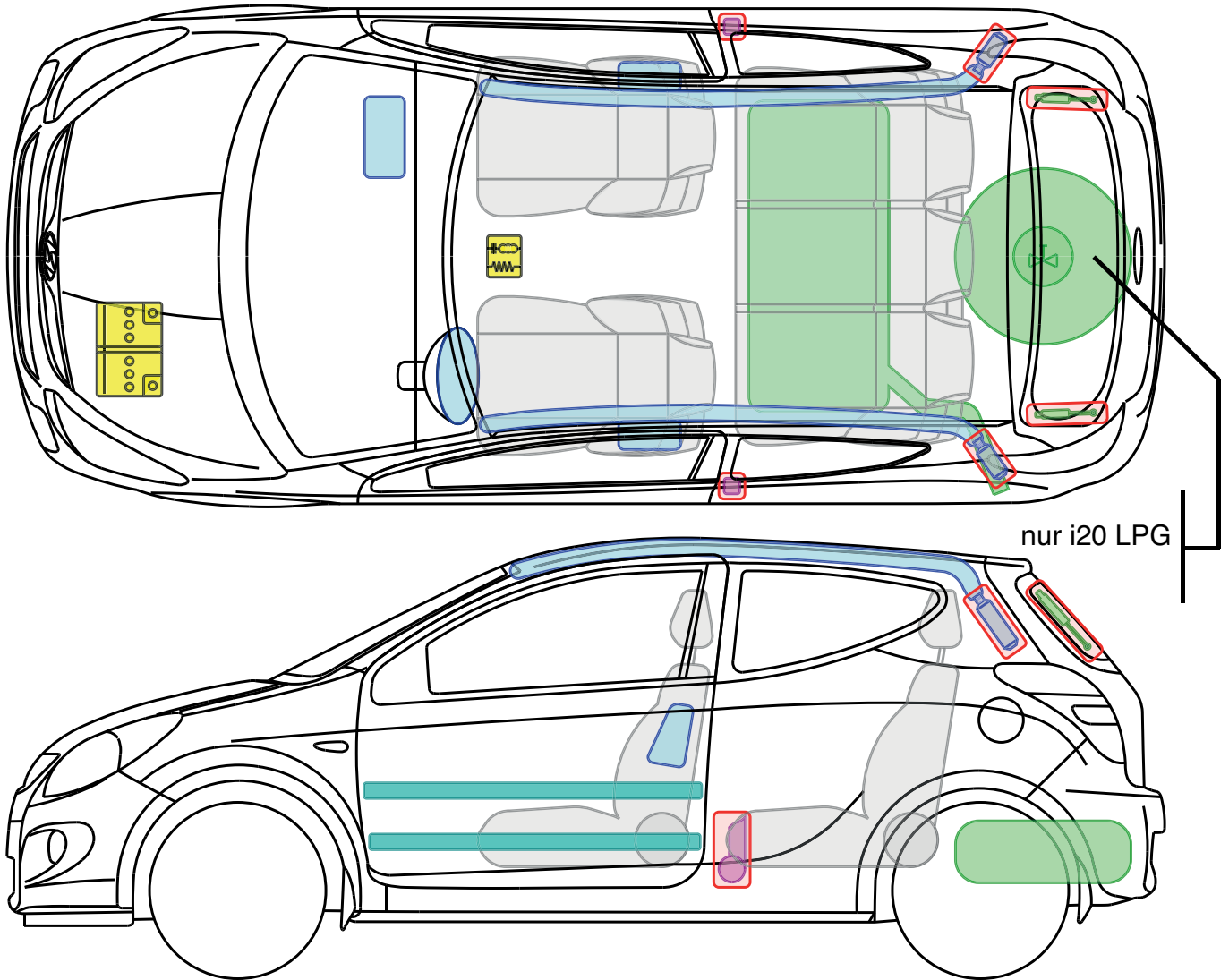
	Airbag		Karosserie- verstärkung		Steuergerät		Gastank
	Gas- generator		Überroll- schutz		12 V Batterie		Sicherheits- ventil
	Gurt- straffer		Gasdruck- dämpfer		Kraftstoff- tank		

**i10**

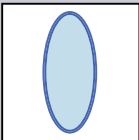
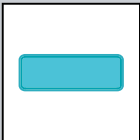

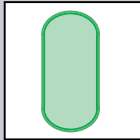
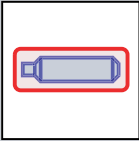
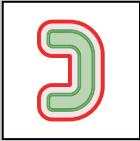
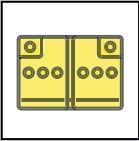

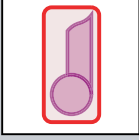
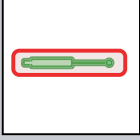
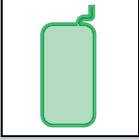

Legende

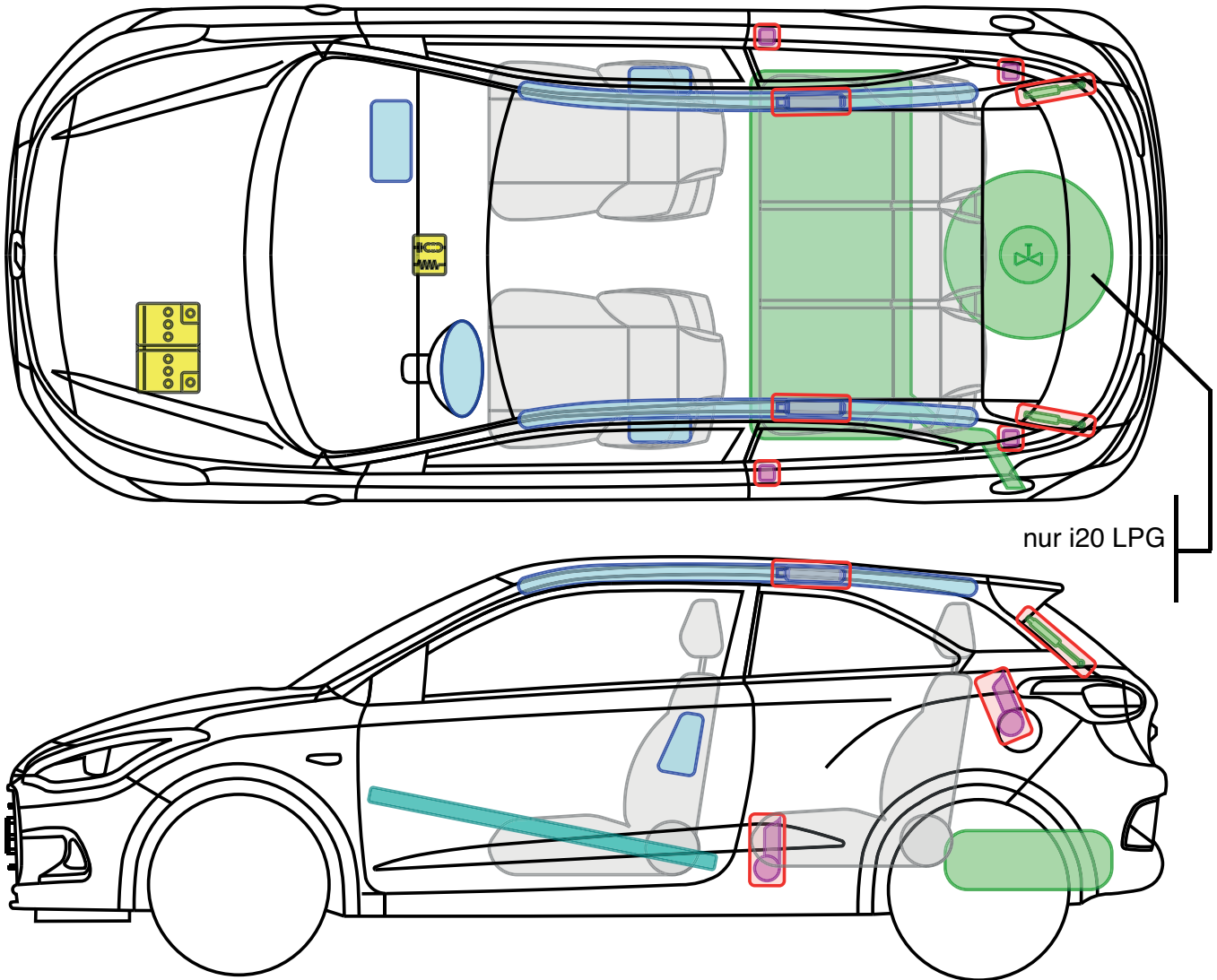
	Airbag		Karosserie- verstärkung		Steuergerät		Gastank
	Gas- generator		Überroll- schutz		12 V Batterie		Sicherheits- ventil
	Gurt- straffer		Gasdruck- dämpfer		Kraftstoff- tank		

**i20**

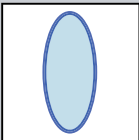
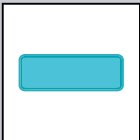

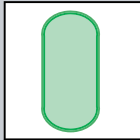
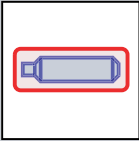
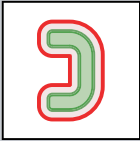
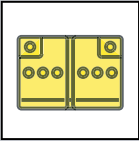

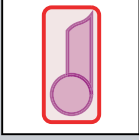
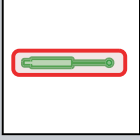
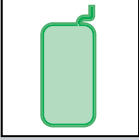

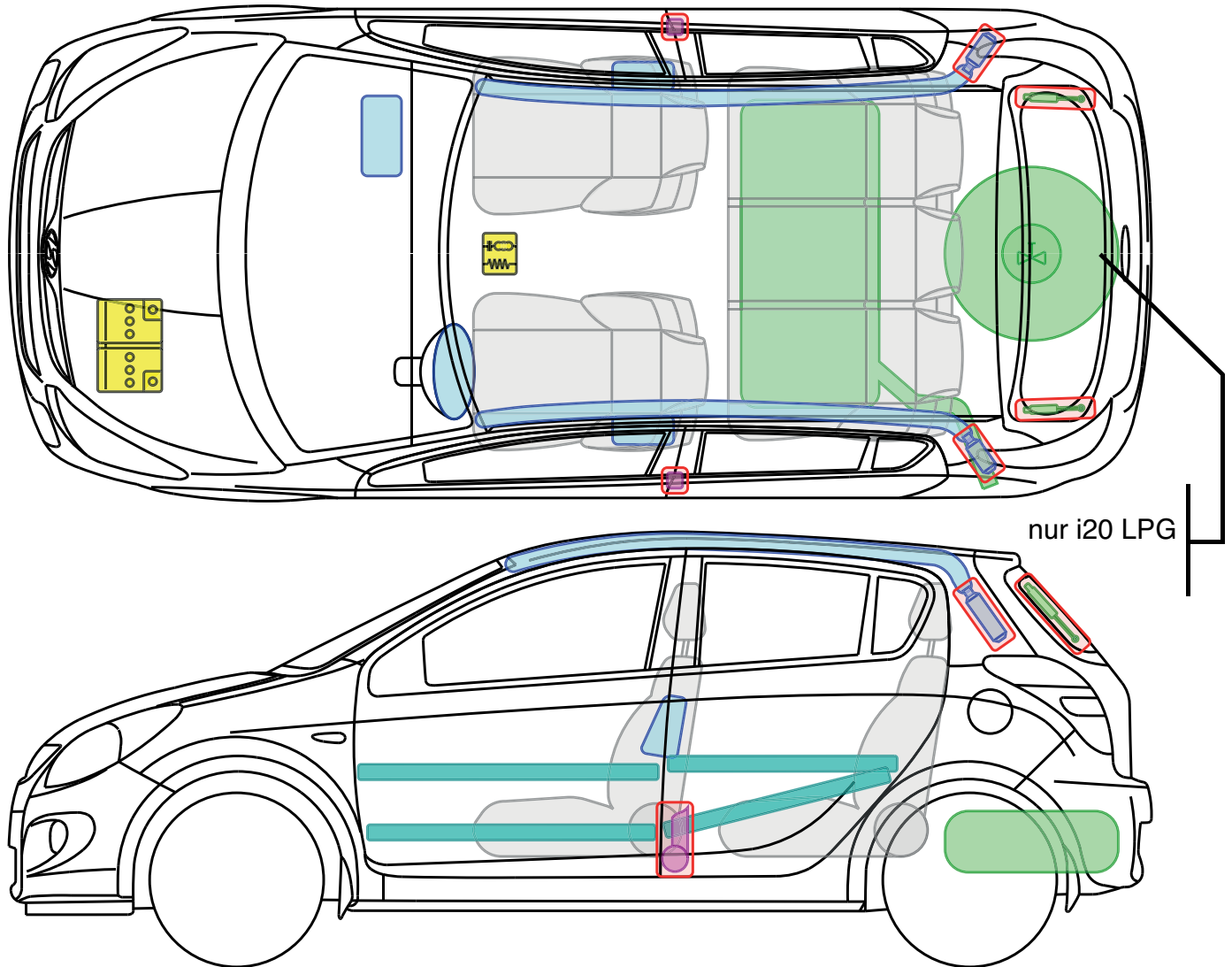

Legende

	Airbag		Karosserie- verstärkung		Steuergerät		Gastank
	Gas- generator		Überroll- schutz		12 V Batterie		Sicherheits- ventil
	Gurt- straffer		Gasdruck- dämpfer		Kraftstoff- tank		

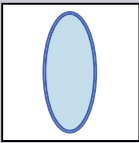
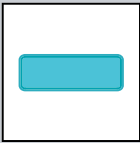
**i20 Coupe**

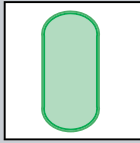
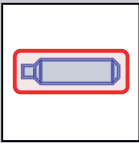
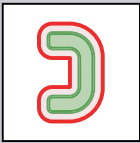
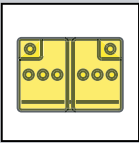

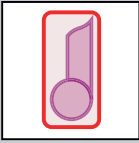
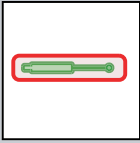

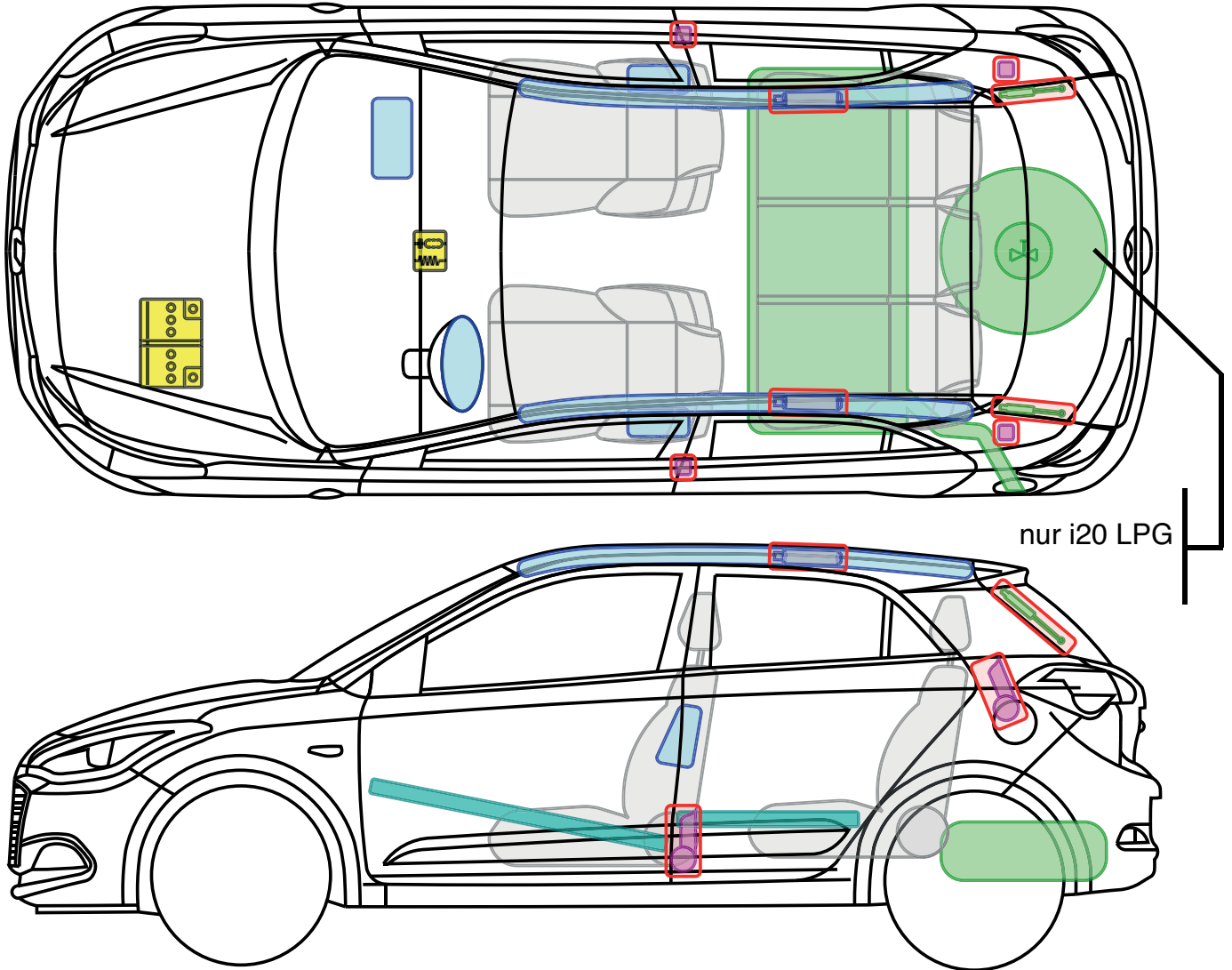

**Legende**

	Airbag		Karosserie- verstärkung		Steuergerät		Gastank
	Gas- generator		Überroll- schutz		12 V Batterie		Sicherheits- ventil
	Gurt- straffer		Gasdruck- dämpfer		Kraftstoff- tank		

**i20**

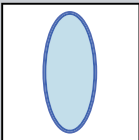
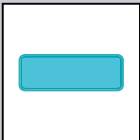

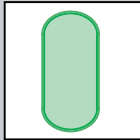
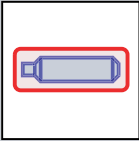
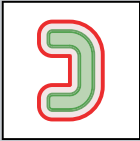
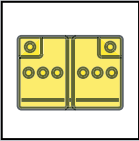
Legende

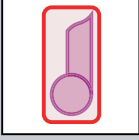
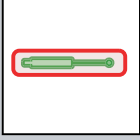
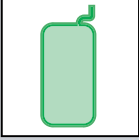

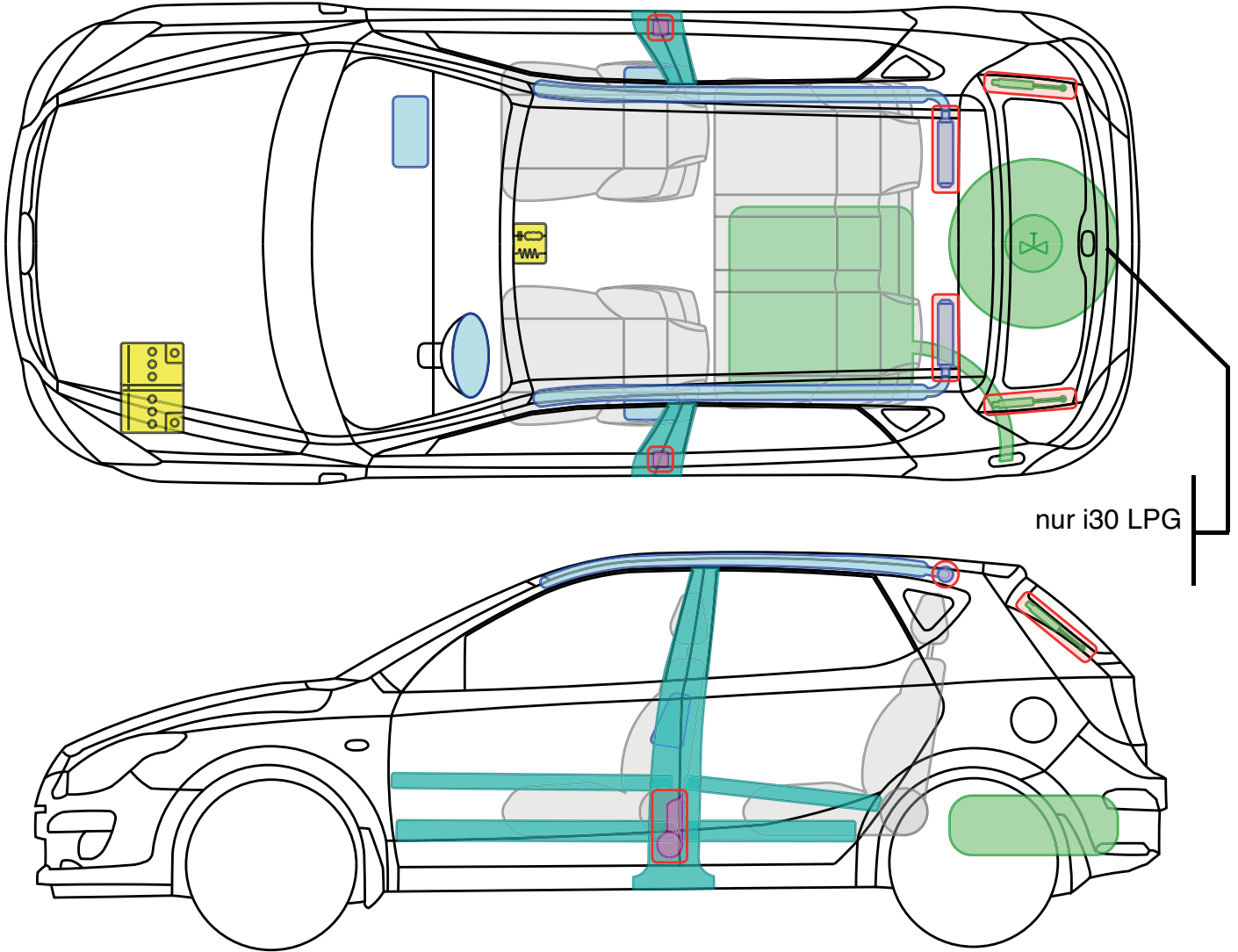

	Airbag		Karosserie- verstärkung		Steuergerät		Gastank
	Gas- generator		Überroll- schutz		12 V Batterie		Sicherheits- ventil
	Gurt- straffer		Gasdruck- dämpfer		Kraftstoff- tank		

**i20**

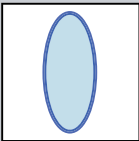
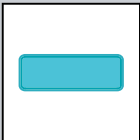

nur i30 LPG

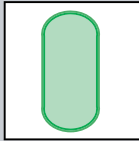
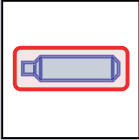
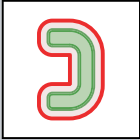
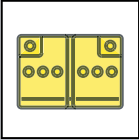

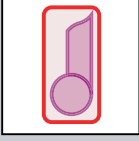
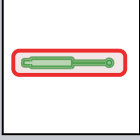
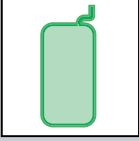

**Legende**

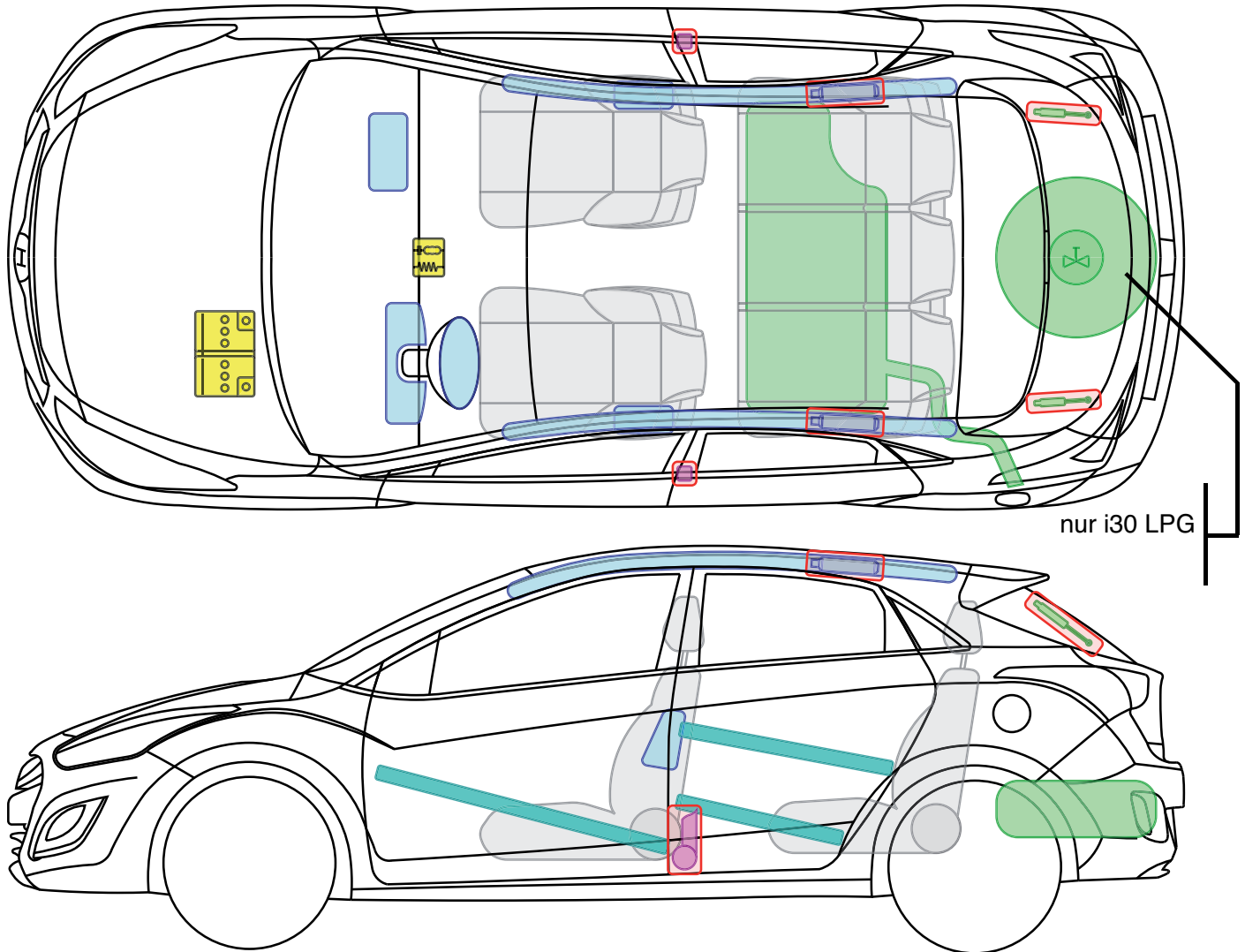
	Airbag		Karosserie- verstärkung		Steuergerät		Gastank
	Gas- generator		Überroll- schutz		12 V Batterie		Sicherheits- ventil
	Gurt- straffer		Gasdruck- dämpfer		Kraftstoff- tank		

**i30**

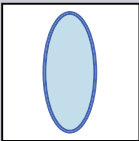
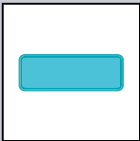

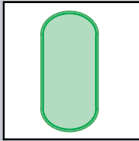
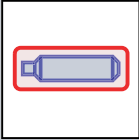
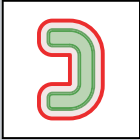
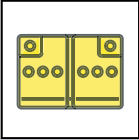

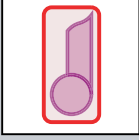
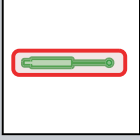
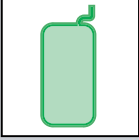
**Legende**

	Airbag		Karosserie- verstärkung		Steuergerät		Gastank
	Gas- generator		Überroll- schutz		12 V Batterie		Sicherheits- ventil
	Gurt- straffer		Gasdruck- dämpfer		Kraftstoff- tank		

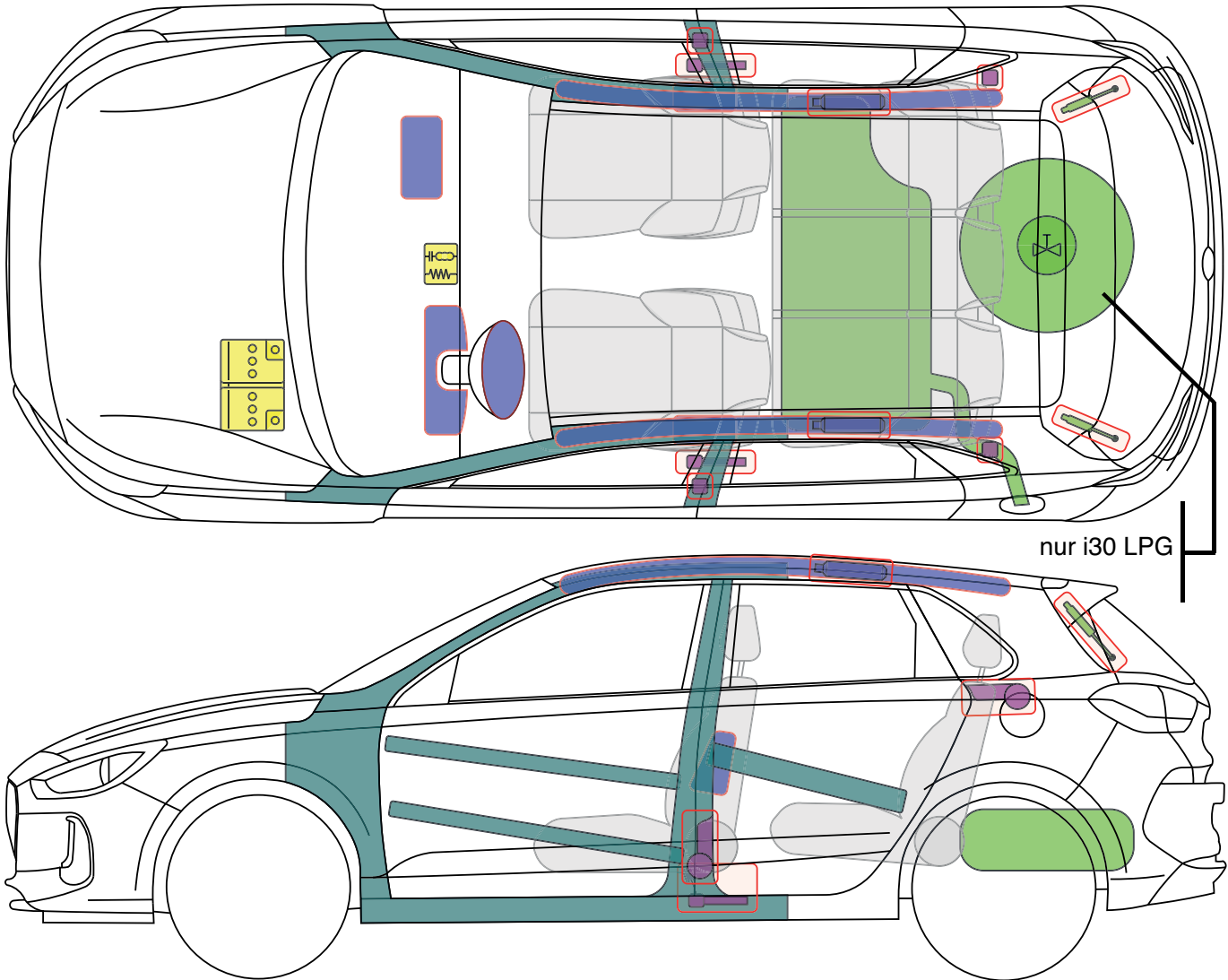
**i30**

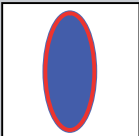
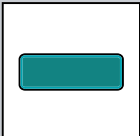
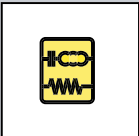
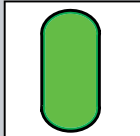
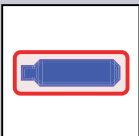
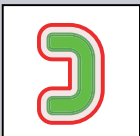
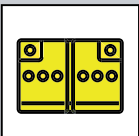

**Legende**

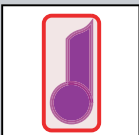
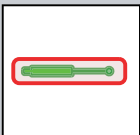
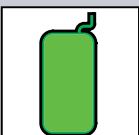

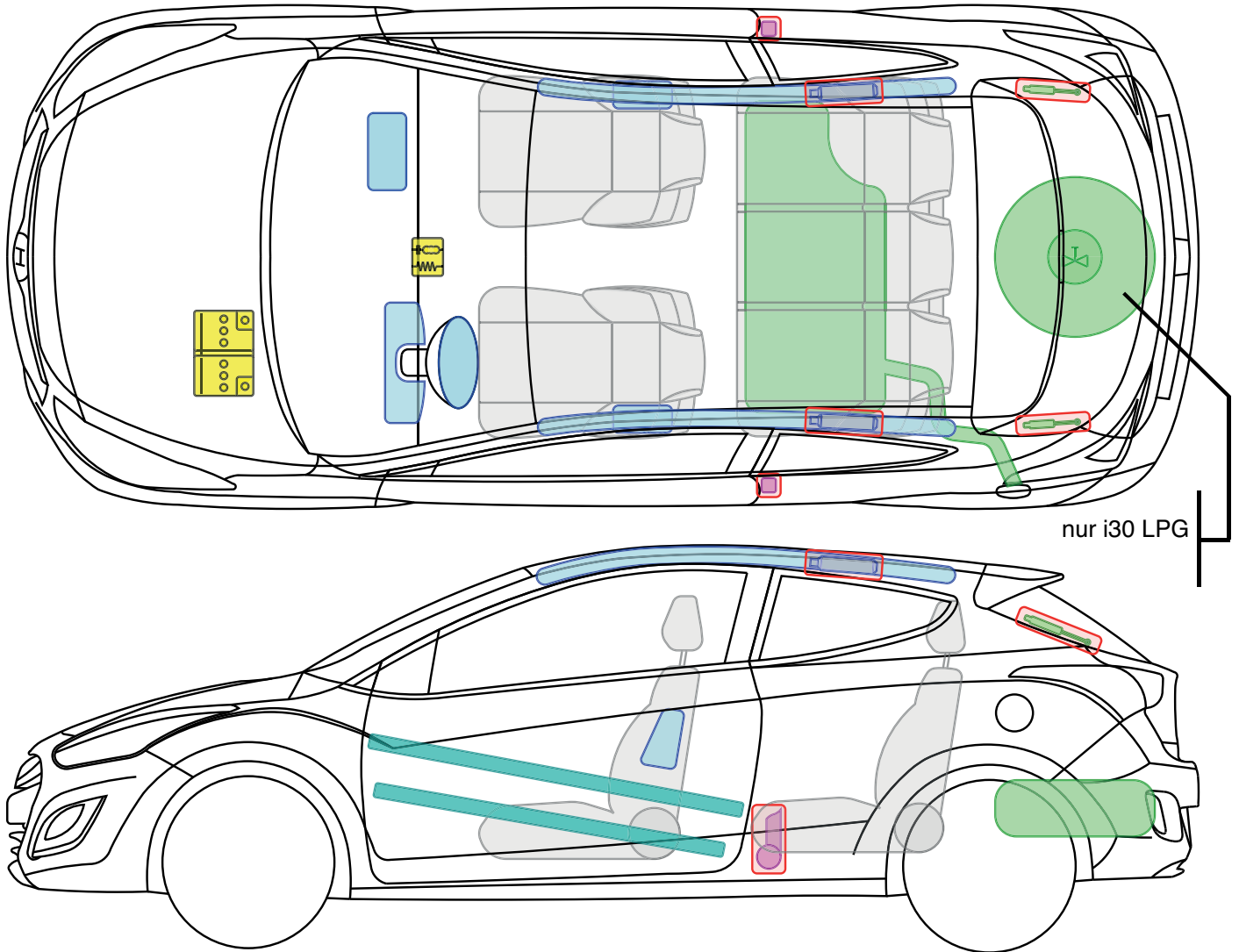

	Airbag		Karosserie- verstärkung		Steuergerät		Gastank
	Gas- generator		Überroll- schutz		12 V Batterie		Sicherheits- ventil
	Gurt- straffer		Gasdruck- dämpfer		Kraftstoff- tank		

**i30**



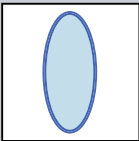
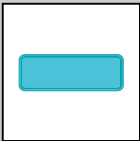

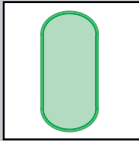
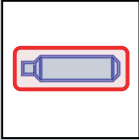
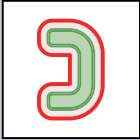
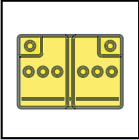

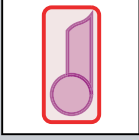
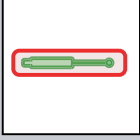
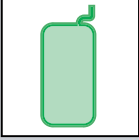

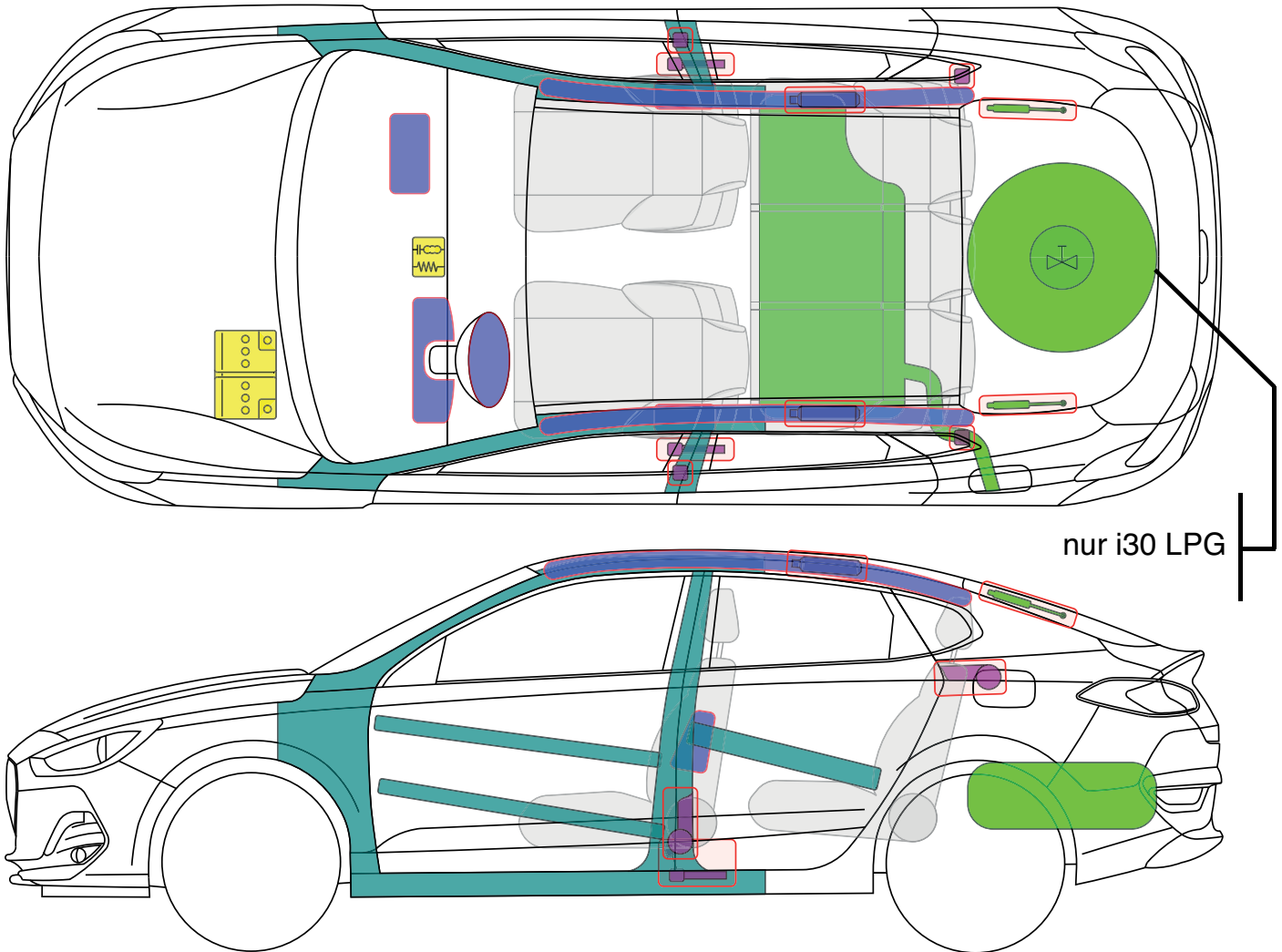

**Legende**

	Airbag		Karosserie- verstärkung		Steuergerät		Gastank
	Gas- generator		Überroll- schutz		12 V Batterie		Sicherheits- ventil
	Gurt- straffer		Gasdruck- dämpfer		Kraftstoff- tank		

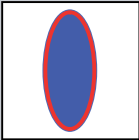
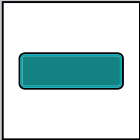
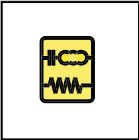
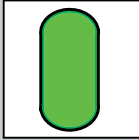
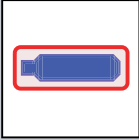
**i30 Coupe**

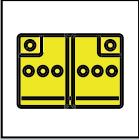

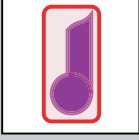
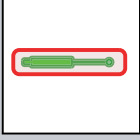

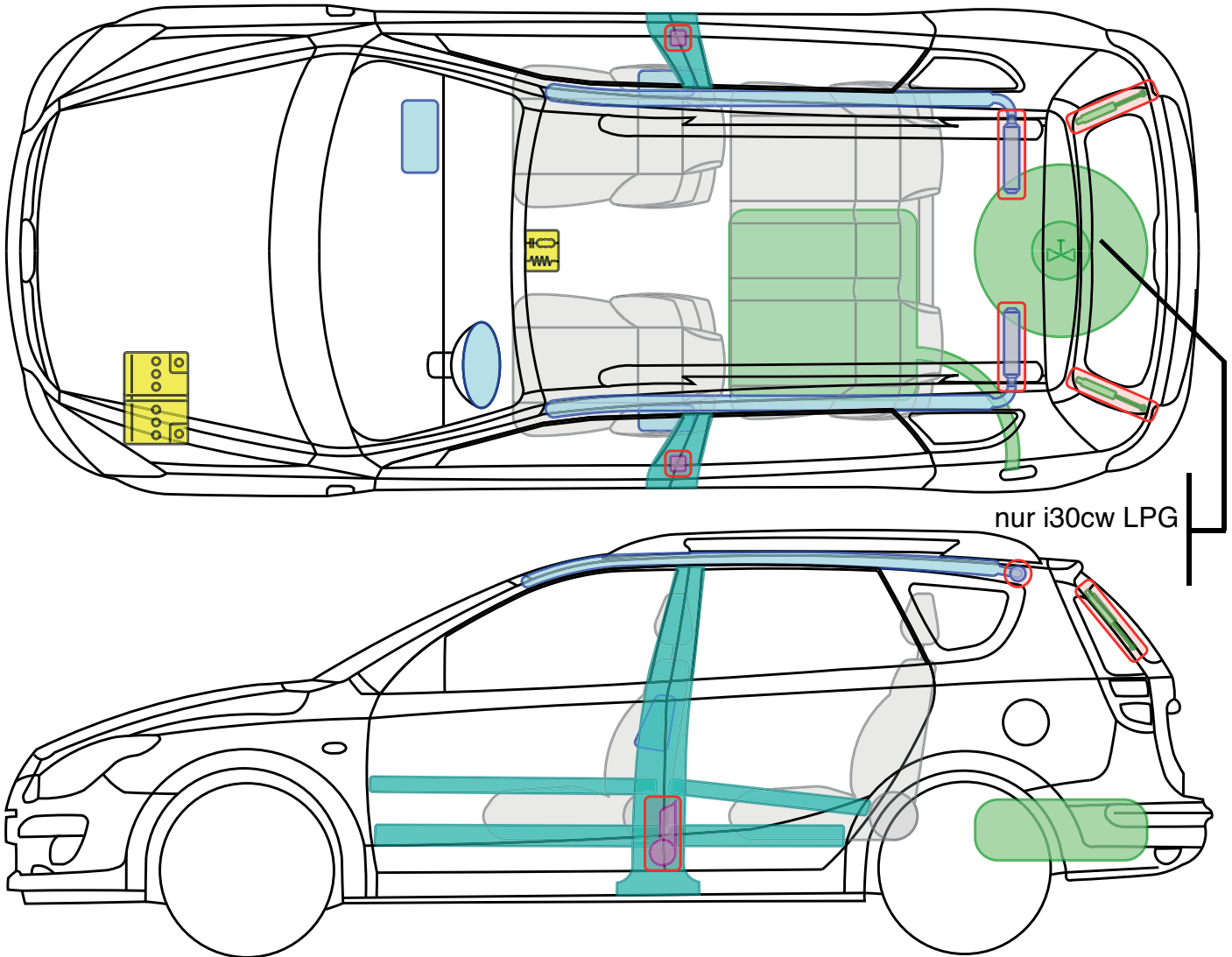

**Legende**

	Airbag		Karosserie- verstärkung		Steuergerät		Gastank
	Gas- generator		Überroll- schutz		12 V Batterie		Sicherheits- ventil
	Gurt- straffer		Gasdruck- dämpfer		Kraftstoff- tank		

**i30 Fastback**

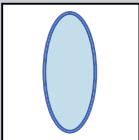
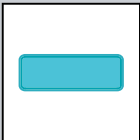

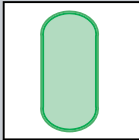
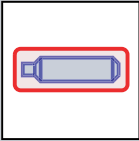
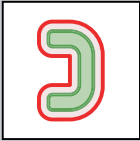
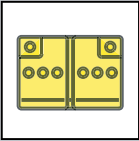

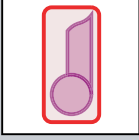
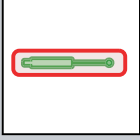
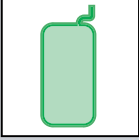

**Legende**

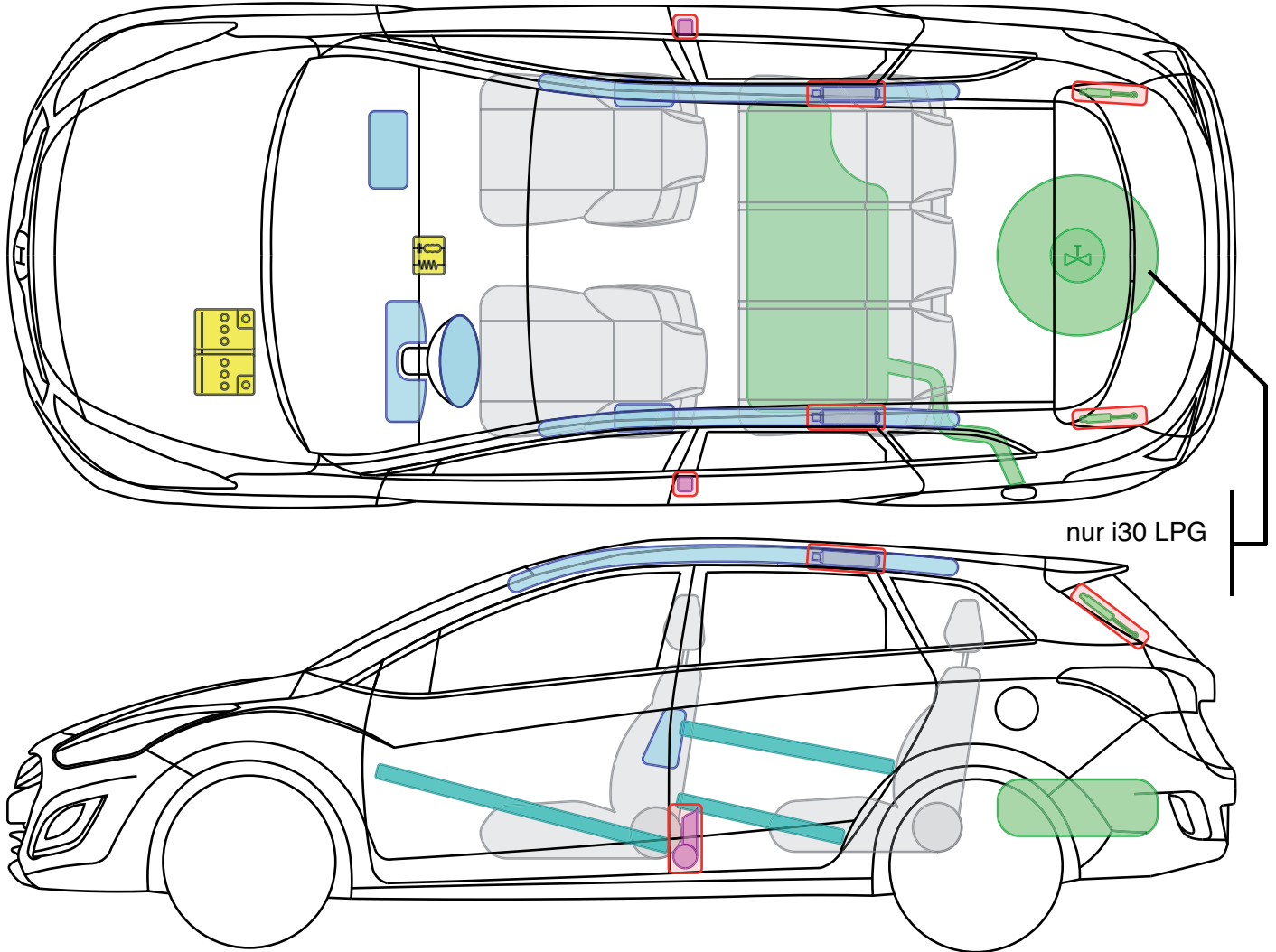
	Airbag		Karosserie- verstärkung		Steuergerät		Gastank
	Gas- generator		Überroll- schutz		12 V Batterie		Sicherheits- ventil
	Gurt- straffer		Gasdruck- dämpfer		Kraftstoff- tank		

**i30cw**

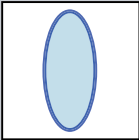
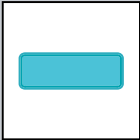

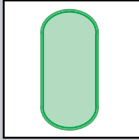
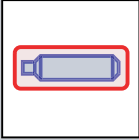
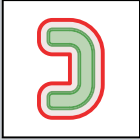
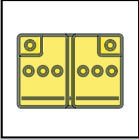

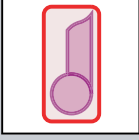
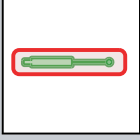
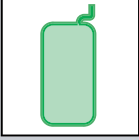

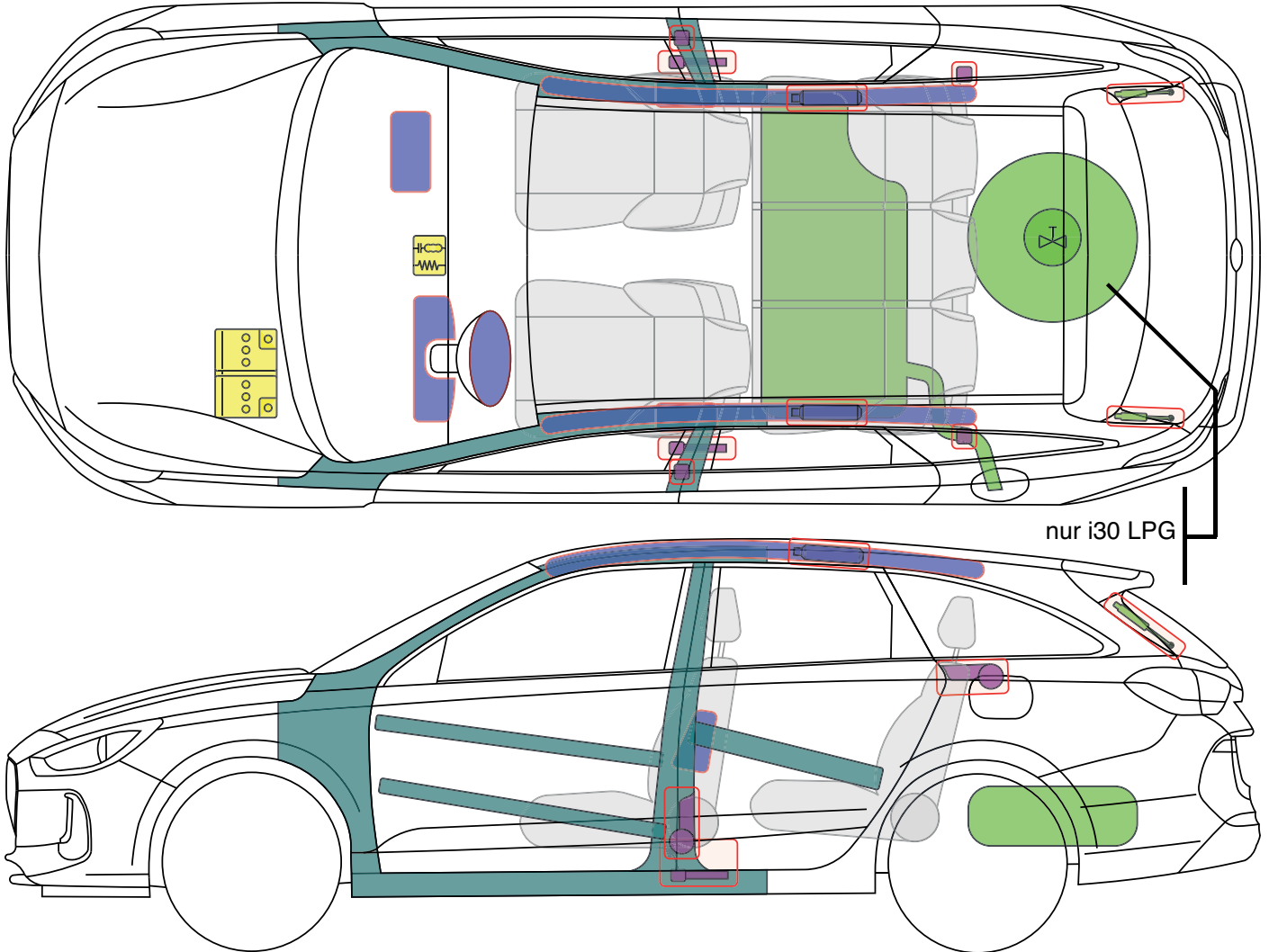

Legende

	Airbag		Karosserie- verstärkung		Steuergerät		Gastank
	Gas- generator		Überroll- schutz		12 V Batterie		Sicherheits- ventil
	Gurt- straffer		Gasdruck- dämpfer		Kraftstoff- tank		

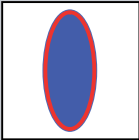
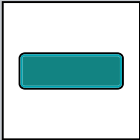
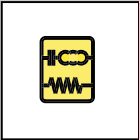
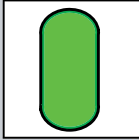
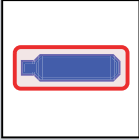
**i30cw**

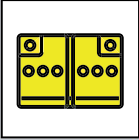

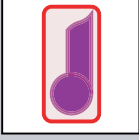
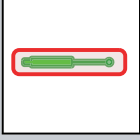



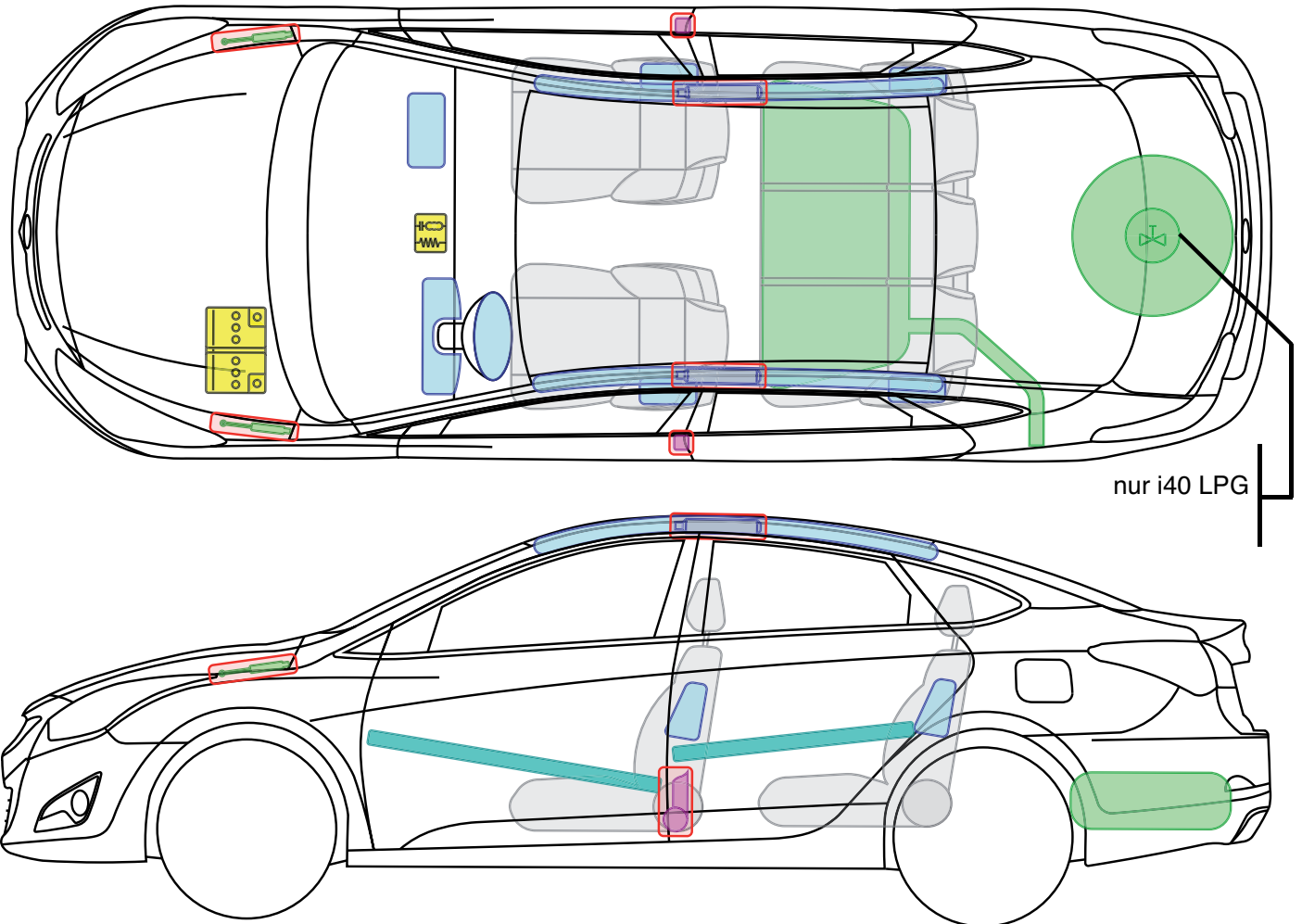

**Legende**

	Airbag		Karosserie- verstärkung		Steuergerät		Gastank
	Gas- generator		Überroll- schutz		12 V Batterie		Sicherheits- ventil
	Gurt- straffer		Gasdruck- dämpfer		Kraftstoff- tank		

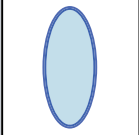
**i30cw**

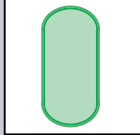
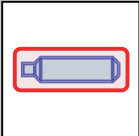
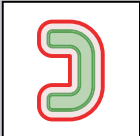
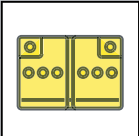

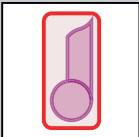
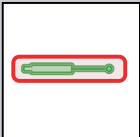

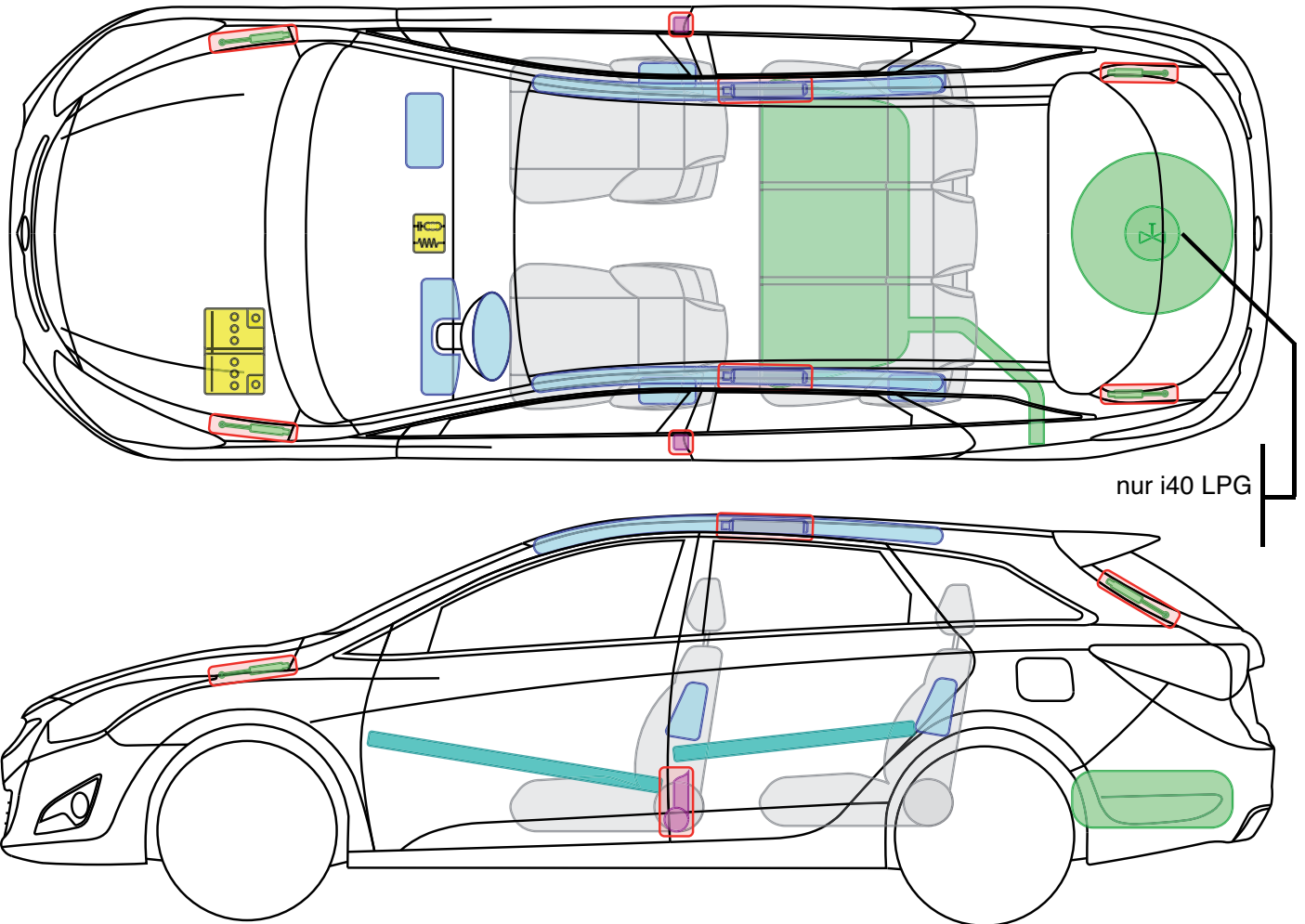

**Legende**

	Airbag		Karosserie- verstärkung		Steuergerät		Gastank
	Gas- generator		Überroll- schutz		12 V Batterie		Sicherheits- ventil
	Gurt- straffer		Gasdruck- dämpfer		Kraftstoff- tank		

**i40**

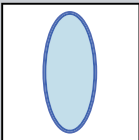
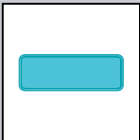

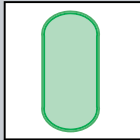
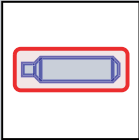
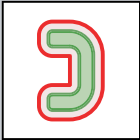
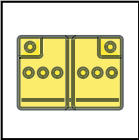

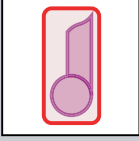
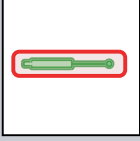
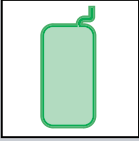

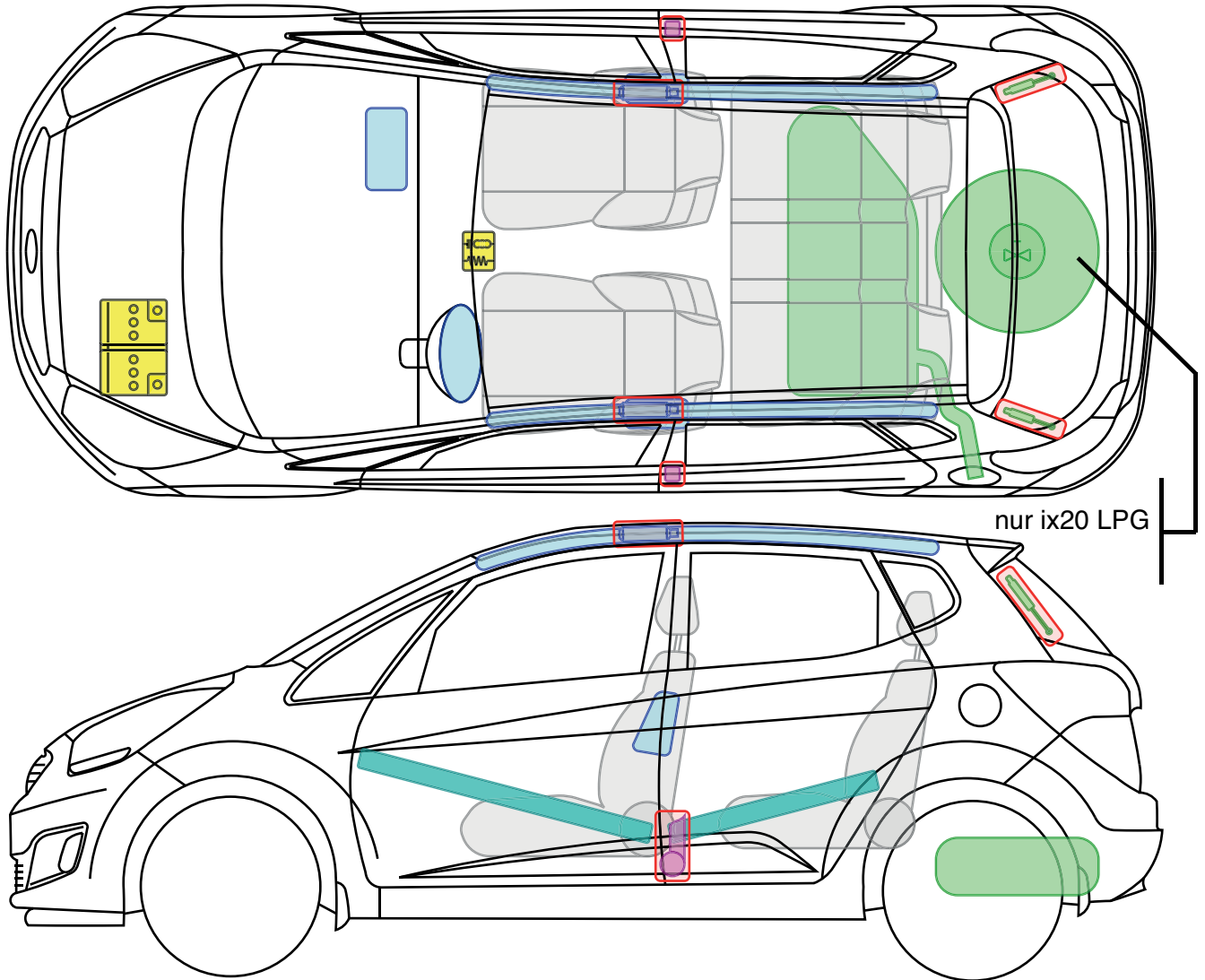

**Legende**

	Airbag		Karosserie- verstärkung		Steuergerät		Gastank
	Gas- generator		Überroll- schutz		12 V Batterie		Sicherheits- ventil
	Gurt- straffer		Gasdruck- dämpfer		Kraftstoff- tank		

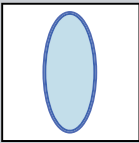
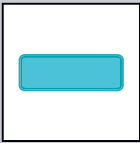
**i40**

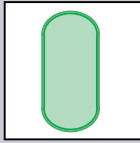
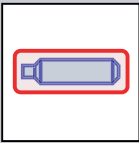
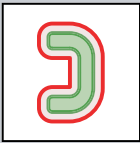
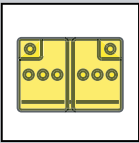

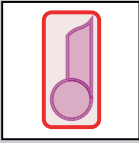
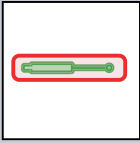
**Legende**



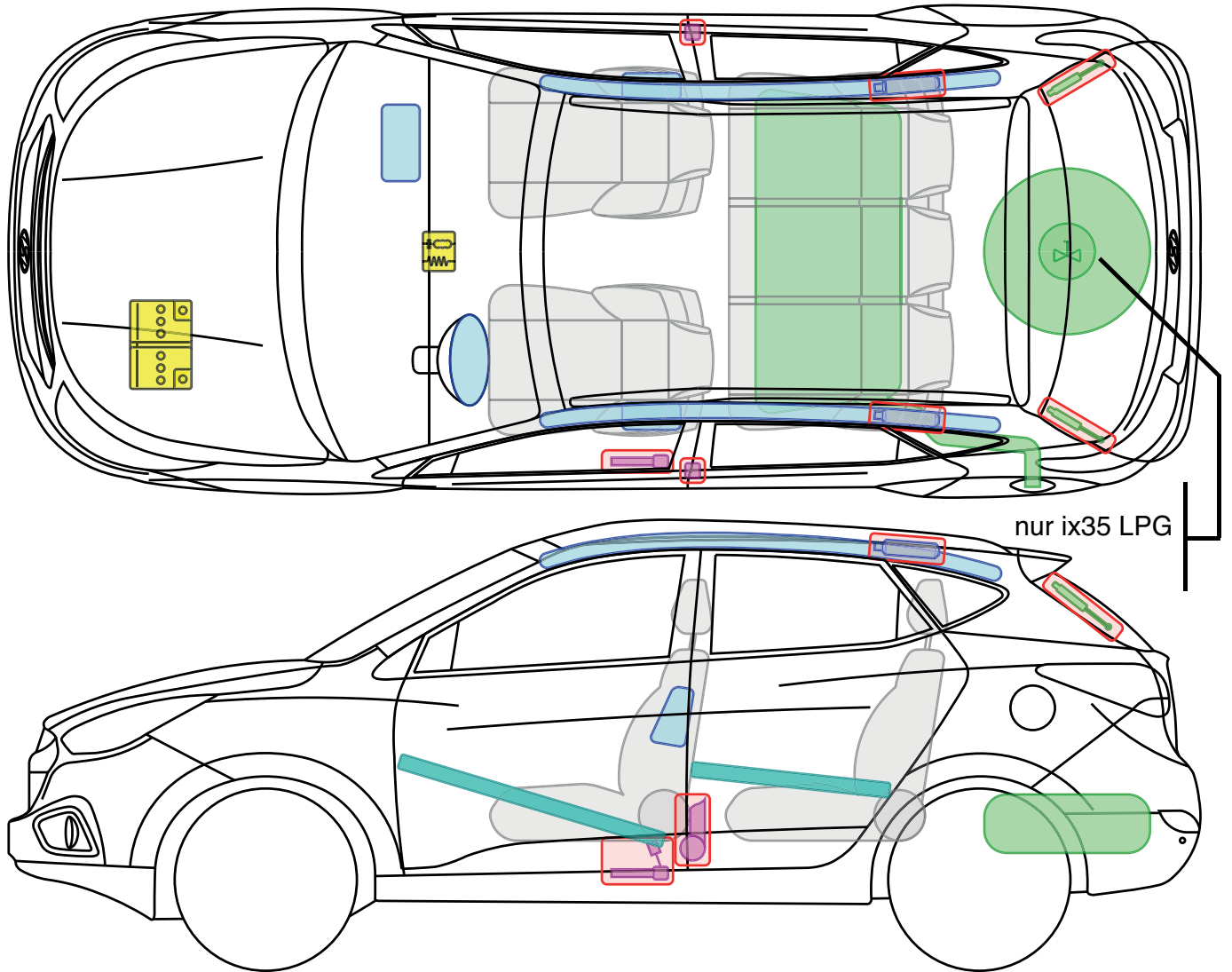

	Airbag		Karosserie- verstärkung		Steuergerät		Gastank
	Gas- generator		Überroll- schutz		12 V Batterie		Sicherheits- ventil
	Gurt- straffer		Gasdruck- dämpfer		Kraftstoff- tank		

**ix20**



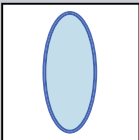
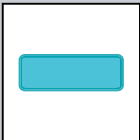

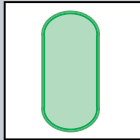
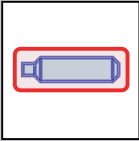
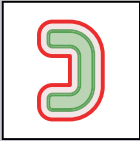
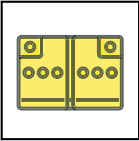

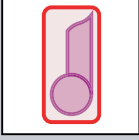
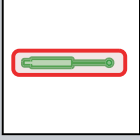
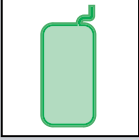



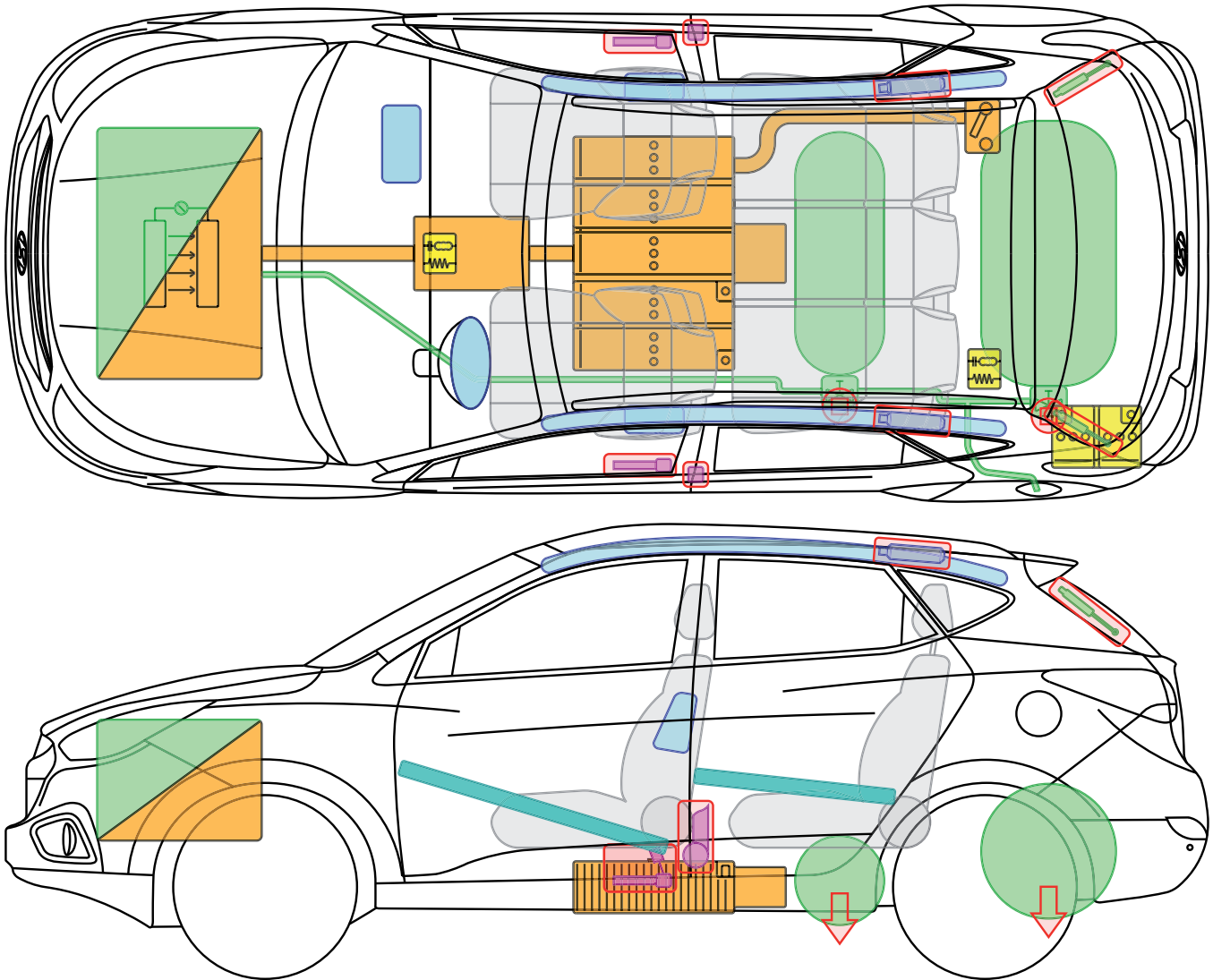



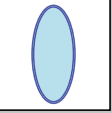

**Legende**

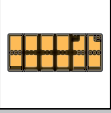
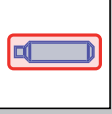
	Airbag		Karosserie- verstärkung		Steuergerät		Gastank
	Gas- generator		Überroll- schutz		12 V Batterie		Sicherheits- ventil
	Gurt- straffer		Gasdruck- dämpfer		Kraftstoff- tank		

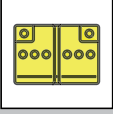
**ix35**

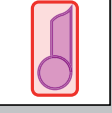
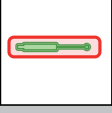

Legende

	Airbag		Karosserie- verstärkung		Steuergerät		Sicherheits- ventil		Hochvolt- batterie
	Gas- generator		Überroll- schutz		12 V Batterie		Brennstoff- zelle		Hochvolt -leitung/ -komponente
	Gurt- straffer		Gasdruck- dämpfer		Kraftstoff- tank		Abblas- richtung		Notfalltrenn- stelle

**ix35 FCEV**



## Allgemeine Hinweise

- Fahrzeug mit elektrischem Brennstoffzellen-System.  
**Druckwasserstoffspeicherung.**
- Initialer Sicherheitsabstand: **50 m**
- Bereich der **Wasserstoff-Abblaseeinrichtung** freihalten (rote Pfeile).
- Hochvoltkomponenten sind mit Warnaufklebern gekennzeichnet.
- Hochvoltkabel verfügen über eine orangefarbene Isolierung.
- Wasserstofftanks verfügen über elektromagnetische Absperrventile, manuelles Schließen nicht möglich.
- Hochvolt- und Wasserstoffsystem werden bei Unfällen mit Airbagauslösung i.d.R. automatisch abgeschaltet.
- Fahrzeug wie angegeben deaktivieren.

## Fahrzeug immobilisieren und deaktivieren

- Gangwahlhebel in Stellung „P“ bringen
- Feststellbremse betätigen.
- Bei eingeschalteter Zündung:
  1. Bremspedal nicht betätigen
  2. Start-Stop Knopf einmal betätigen



- 12 Volt Batterie abklemmen







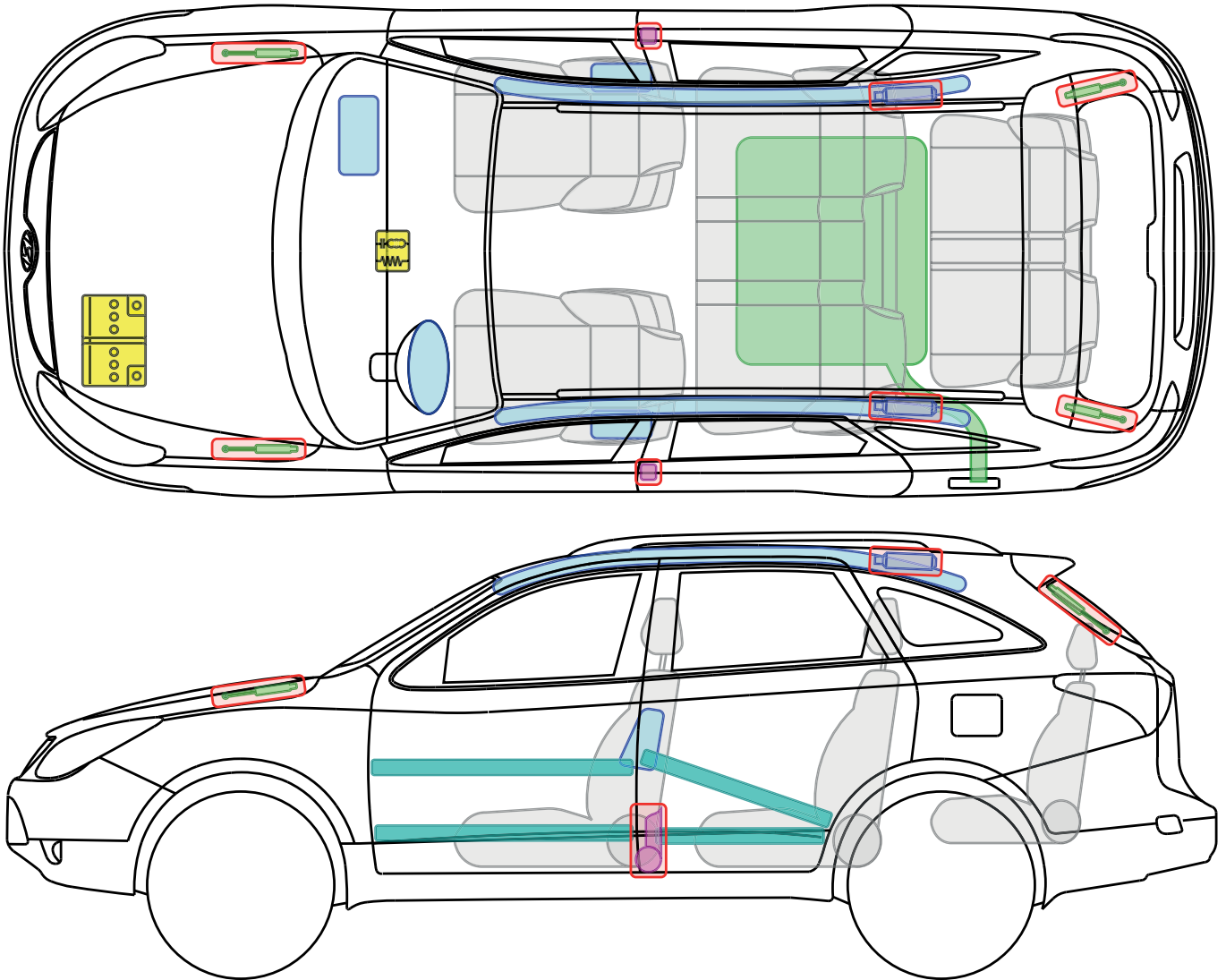

- Service Disconnect Stecker entfernen  
(isolierende Schutzhandschuhe bis 1000V erforderlich)

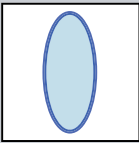
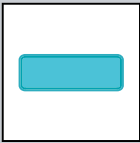

**ix35 FCEV**

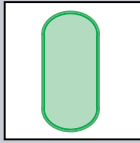
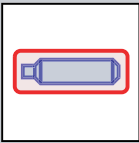
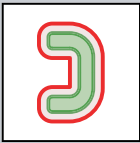
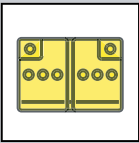

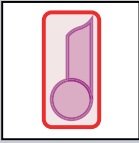
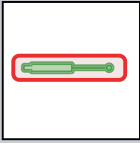





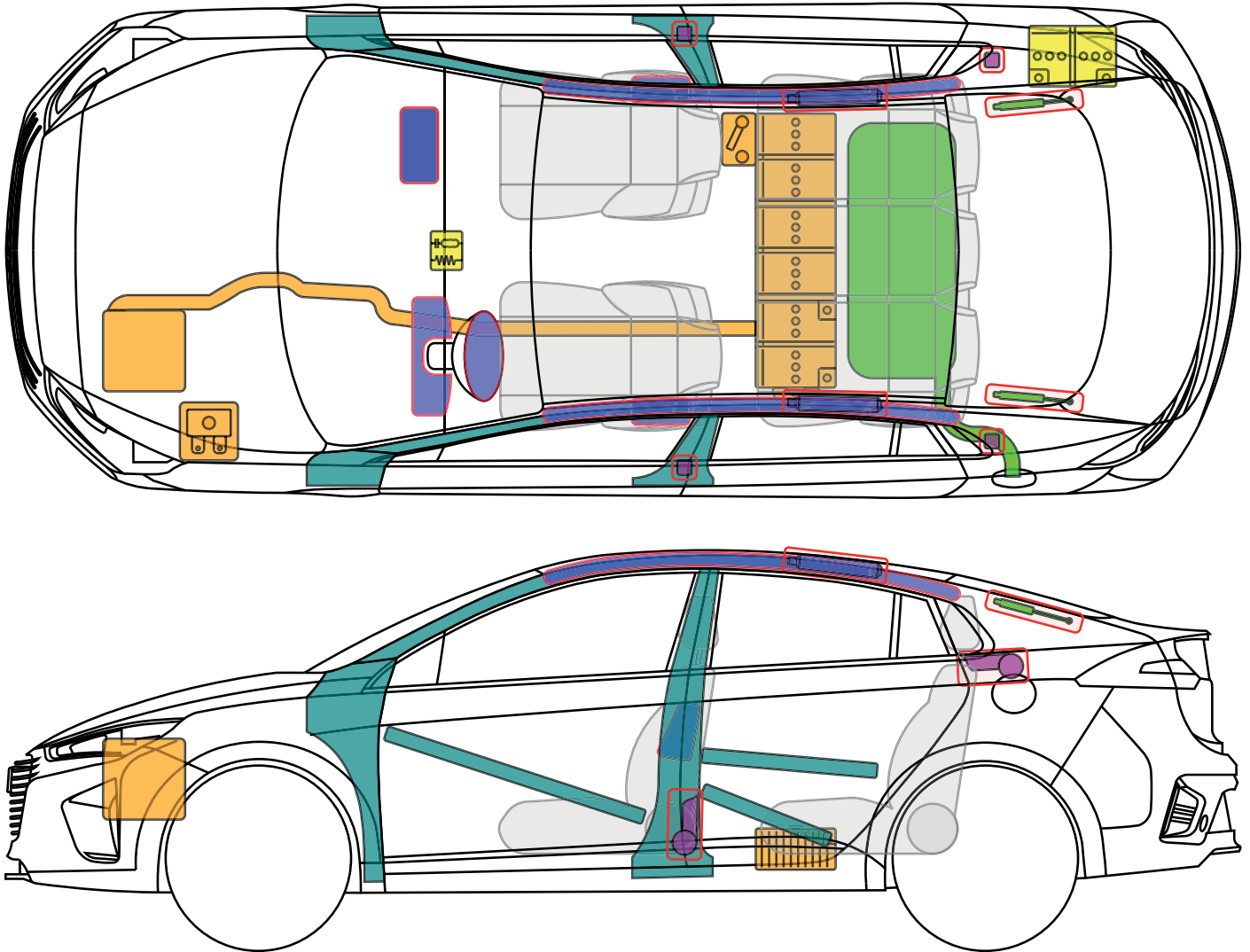



Legende

	Airbag		Karosserie- verstärkung		Steuergerät		Gastank
	Gas- generator		Überroll- schutz		12 V Batterie		Sicherheits- ventil
	Gurt- straffer		Gasdruck- dämpfer		Kraftstoff- tank		

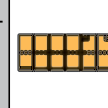
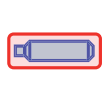
**ix55**

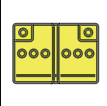

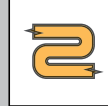
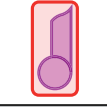
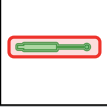

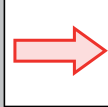
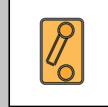



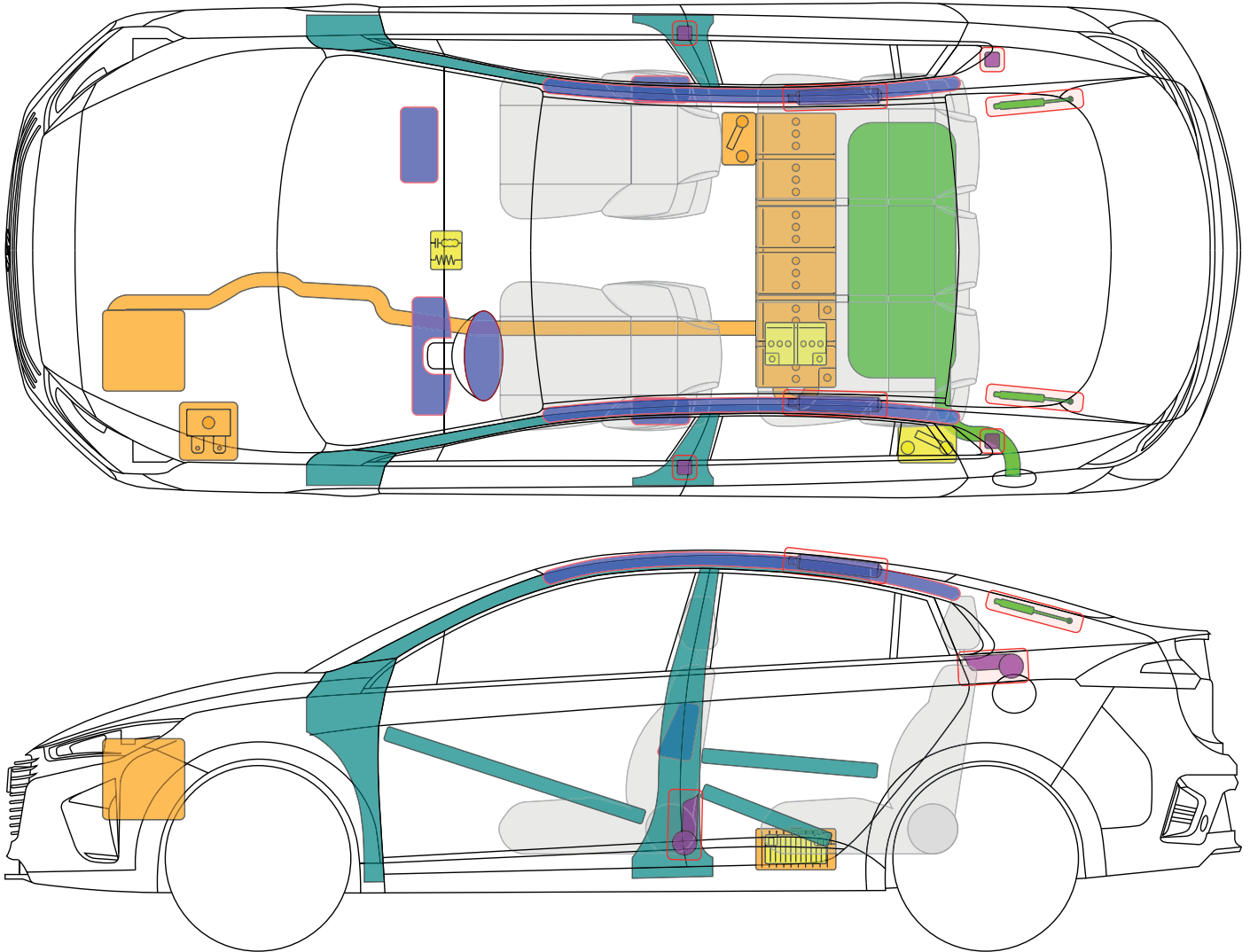

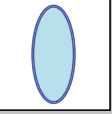

Legende

	Airbag		Karosserie- verstärkung		Steuergerät		Sicherheits- ventil		Hochvolt- batterie
	Gas- generator		Überroll- schutz		12 V Batterie		Brennstoff- zelle		Hochvolt -leitung/ -komponente
	Gurt- straffer		Gasdruck- dämpfer		Kraftstoff- tank		Abblas- richtung		Notfalltrenn- stelle

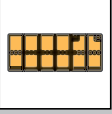
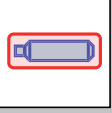
**Ioniq Hybrid**

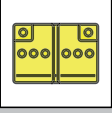

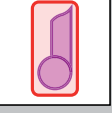
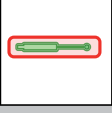

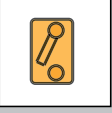



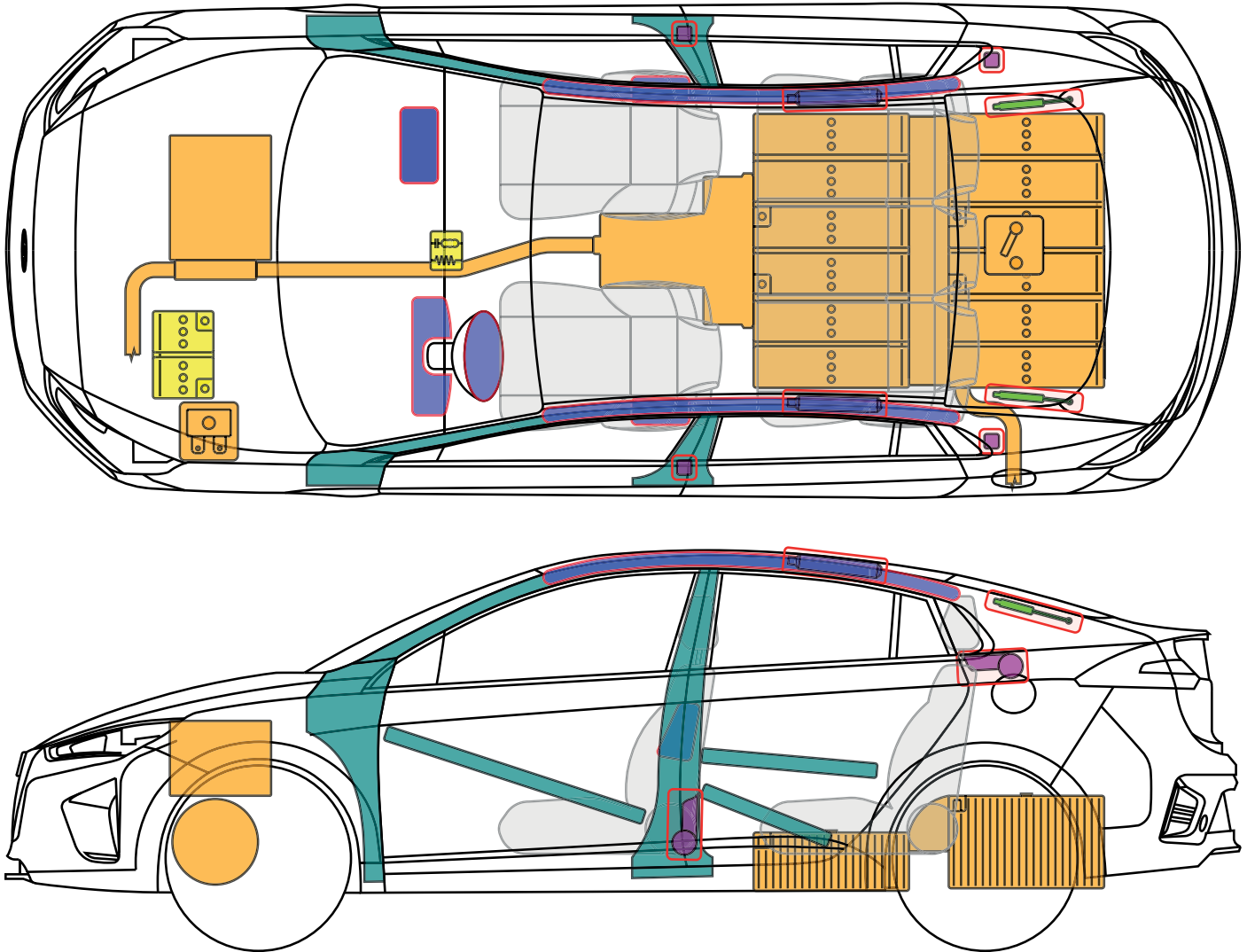



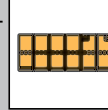
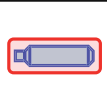

**Legende**

	Airbag		Karosserie- verstärkung		Steuergerät		Sicherheits- ventil		Hochvolt- batterie
	Gas- generator		Überroll- schutz		12 V Batterie		Brennstoff- zelle		Hochvolt -leitung/ -komponente
	Gurt- straffer		Gasdruck- dämpfer		Kraftstoff- tank		Abblas- richtung		Notfalltrenn- stelle

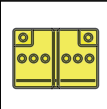
**Ioniq Hybrid**

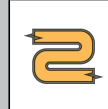

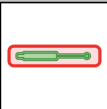

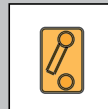



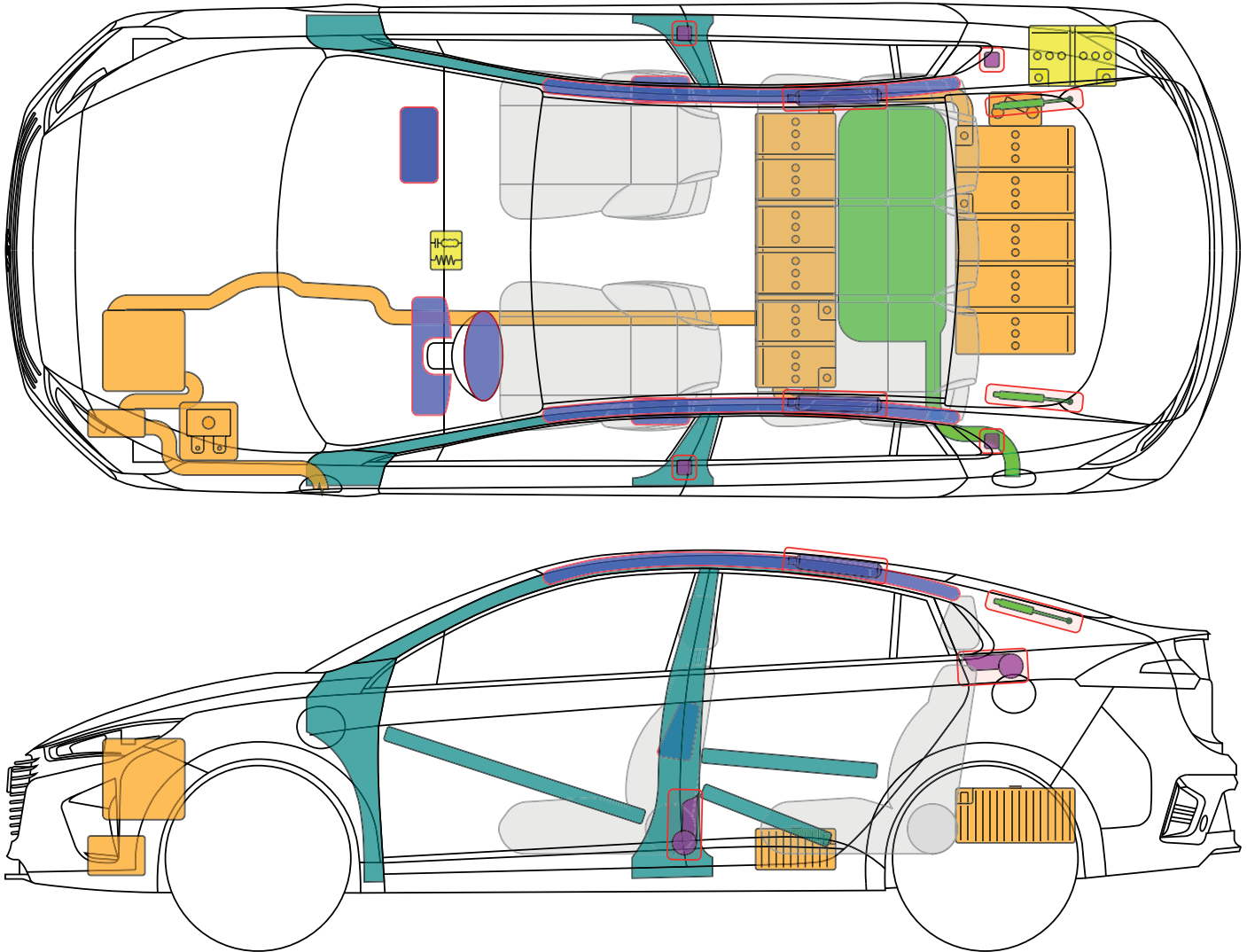



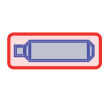

Legende

	Airbag		Karosserie- verstärkung		Steuergerät		Sicherheits- ventil		Hochvolt- batterie
	Gas- generator		Überroll- schutz		12 V Batterie		Brennstoff- zelle		Hochvolt -leitung/ -komponente
	Gurt- straffer		Gasdruck- dämpfer		Kraftstoff- tank		Abblas- richtung		Notfalltrenn- stelle

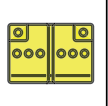
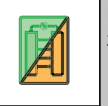
**Ioniq Elektro**

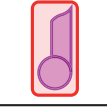
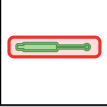

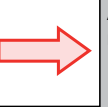
**Legende**

	Airbag		Karosserie- verstärkung		Steuergerät		Sicherheits- ventil		Hochvolt- batterie
	Gas- generator		Überroll- schutz		12 V Batterie		Brennstoff- zelle		Hochvolt -leitung/ -komponente
	Gurt- straffer		Gasdruck- dämpfer		Kraftstoff- tank		Abblas- richtung		Notfalltrenn- stelle



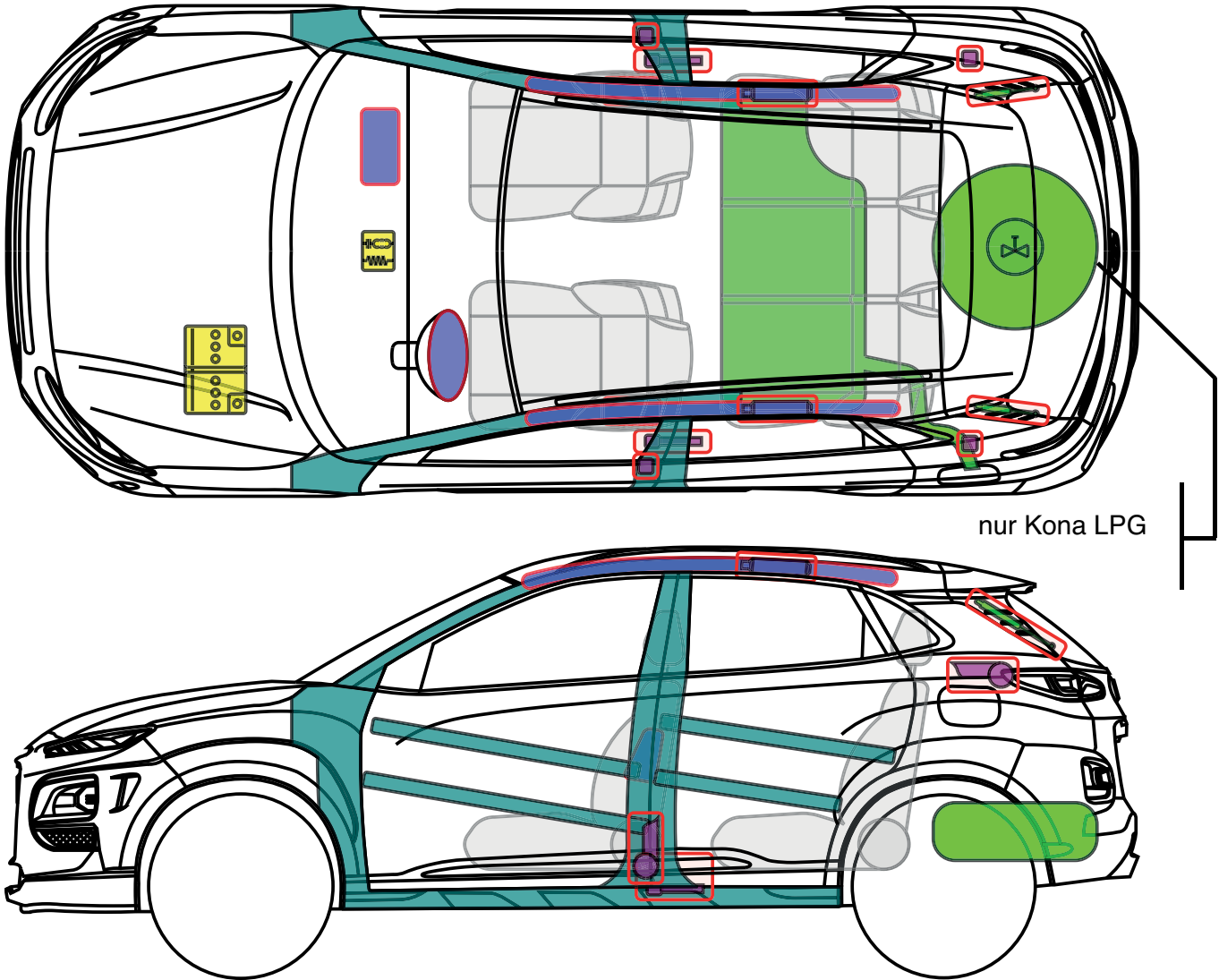

**Ioniq Plug-in Hybrid**



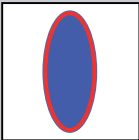
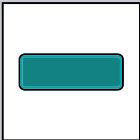
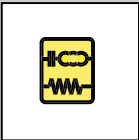
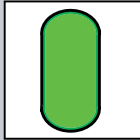
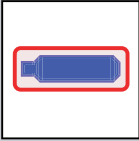

nur Kona LPG

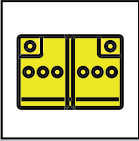
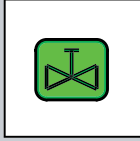
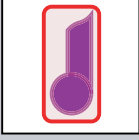
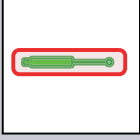
Legende

	Airbag		Karosserie- verstärkung		Steuergerät		Gastank
	Gas- generator		Überroll- schutz		12 V Batterie		Sicherheits- ventil
	Gurt- straffer		Gasdruck- dämpfer		Kraftstoff- tank		



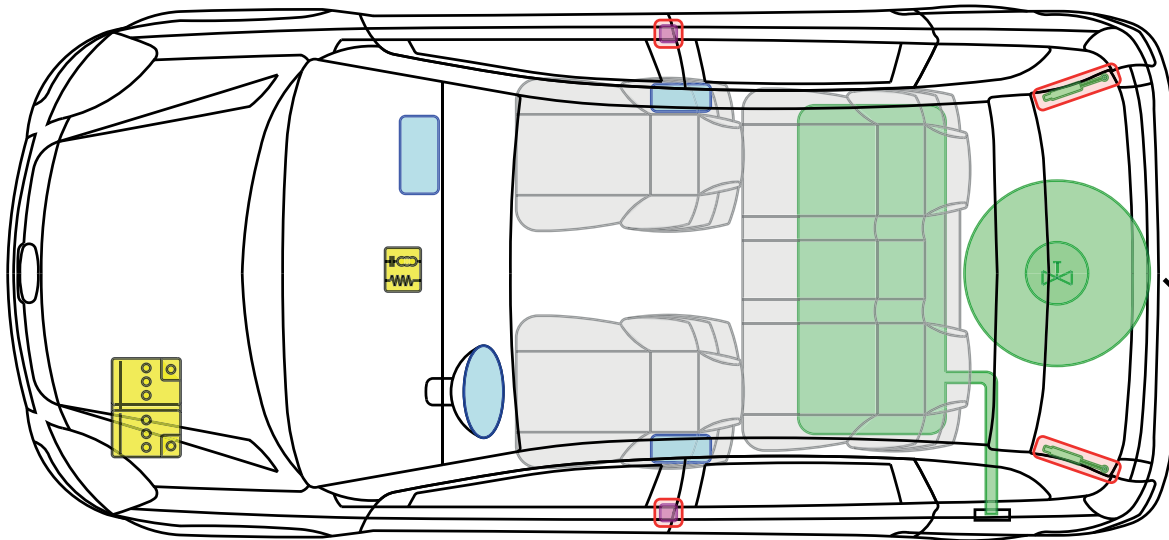

**Kona**

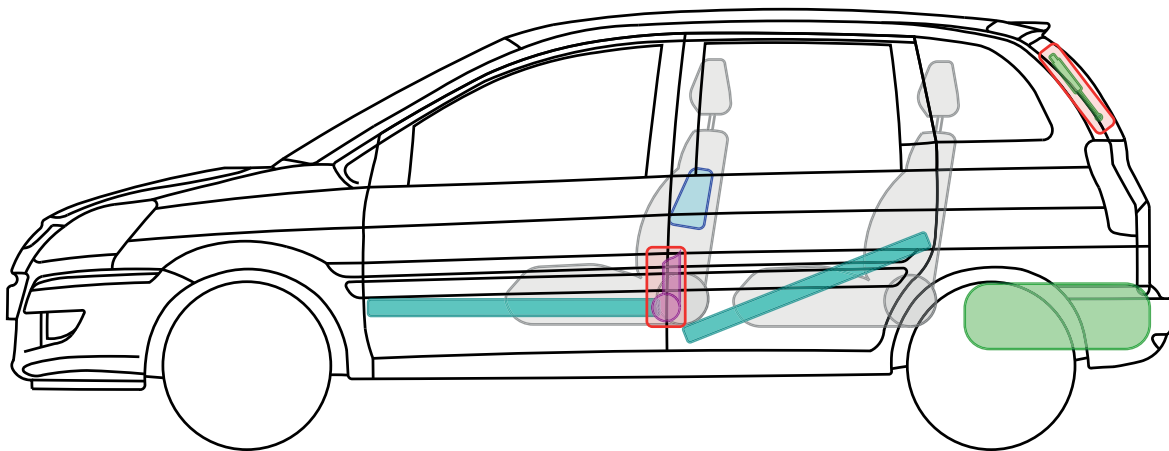

nur Matrix LPG

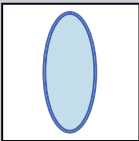
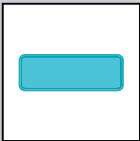

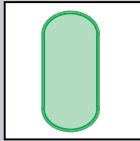
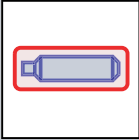
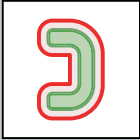
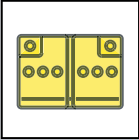

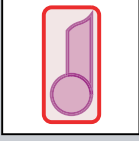
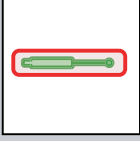
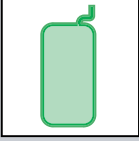

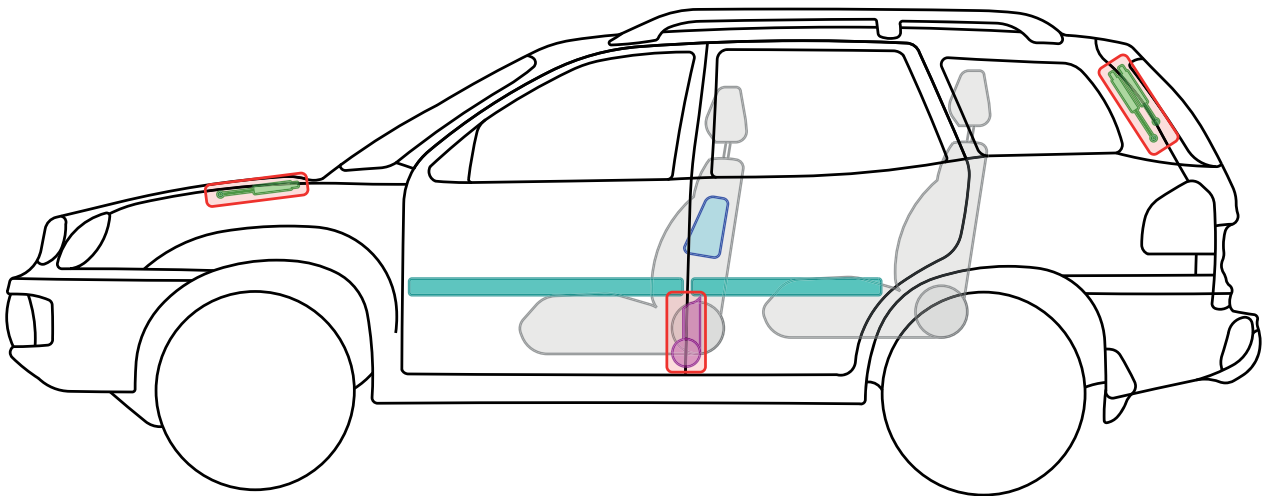
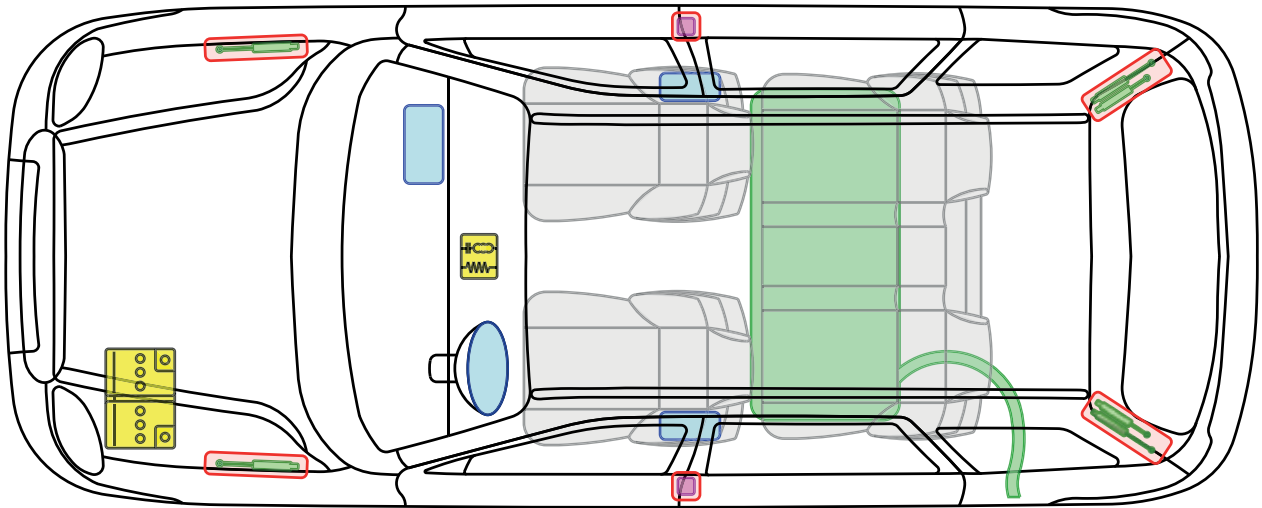

**Legende**

	Airbag		Karosserie- verstärkung		Steuergerät		Gastank
	Gas- generator		Überroll- schutz		12 V Batterie		Sicherheits- ventil
	Gurt- straffer		Gasdruck- dämpfer		Kraftstoff- tank		

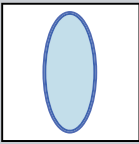
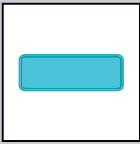
**Matrix**

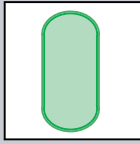
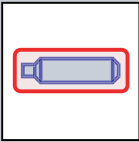
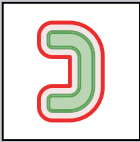
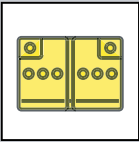

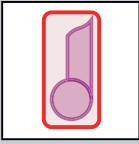
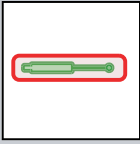

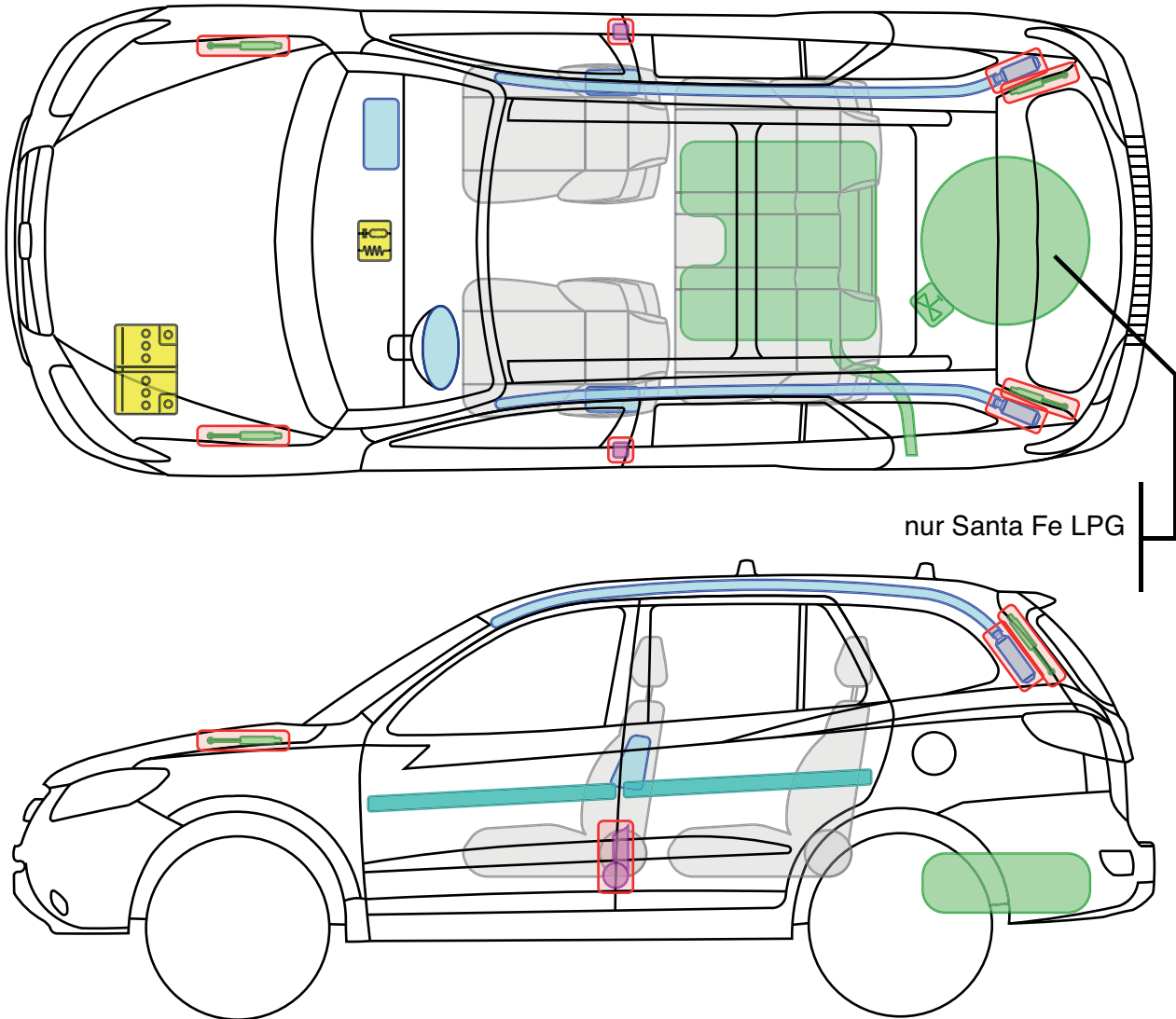

**Legende**

	Airbag		Karosserie- verstärkung		Steuergerät		Gastank
	Gas- generator		Überroll- schutz		12 V Batterie		Sicherheits- ventil
	Gurt- straffer		Gasdruck- dämpfer		Kraftstoff- tank		

**Santa Fe**

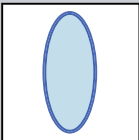
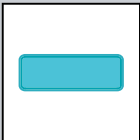

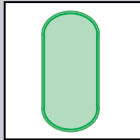
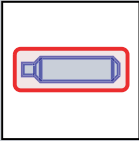
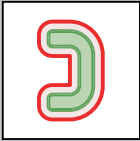
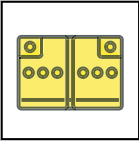
Legende

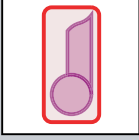
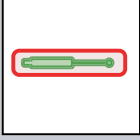
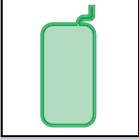
	Airbag		Karosserie- verstärkung		Steuergerät		Gastank
	Gas- generator		Überroll- schutz		12 V Batterie		Sicherheits- ventil
	Gurt- straffer		Gasdruck- dämpfer		Kraftstoff- tank		

**Santa Fe**



**(Grand) Santa Fe**  
**5-Türer**  
 (Typ DM/NC, ab 2012)

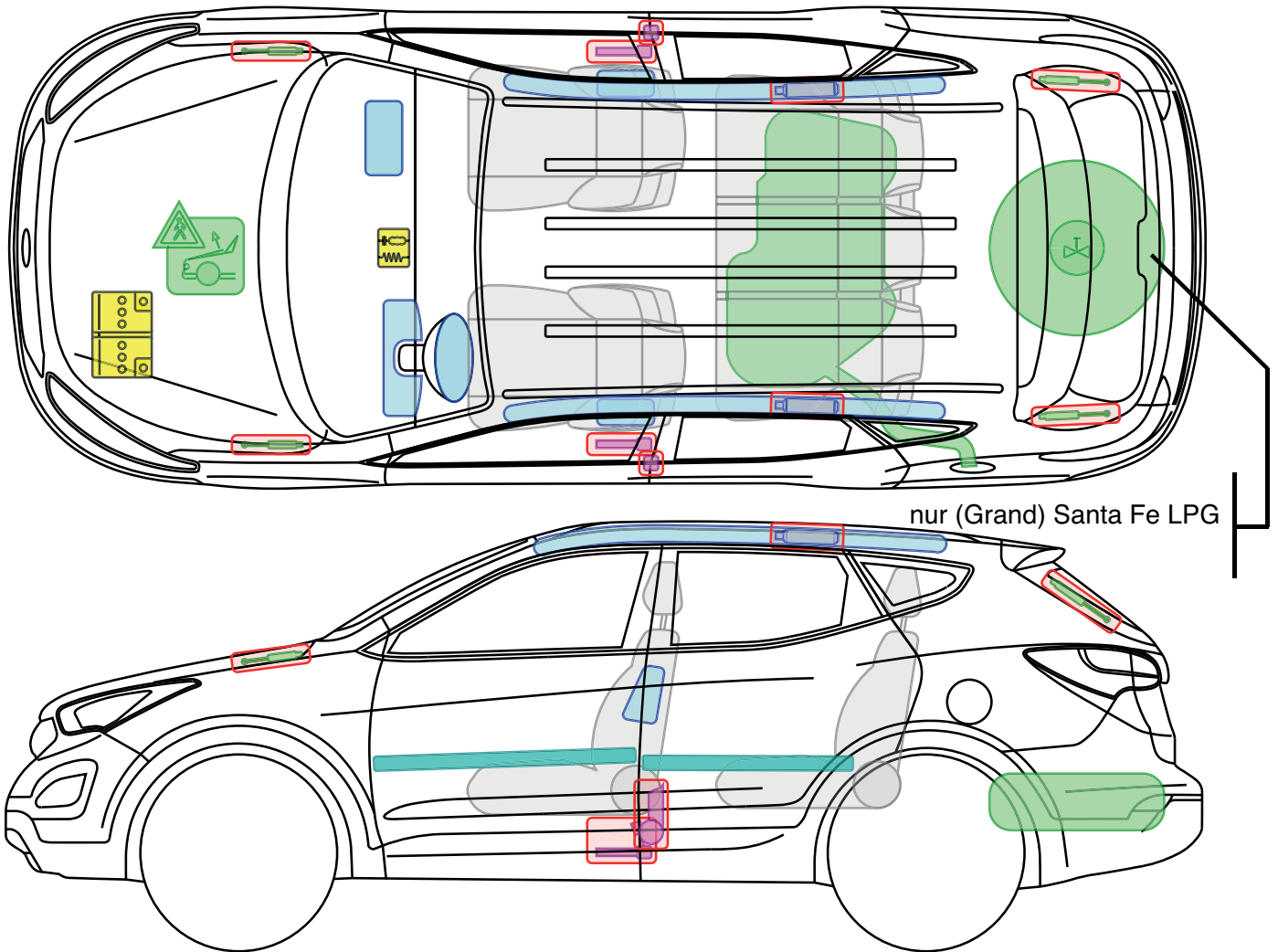



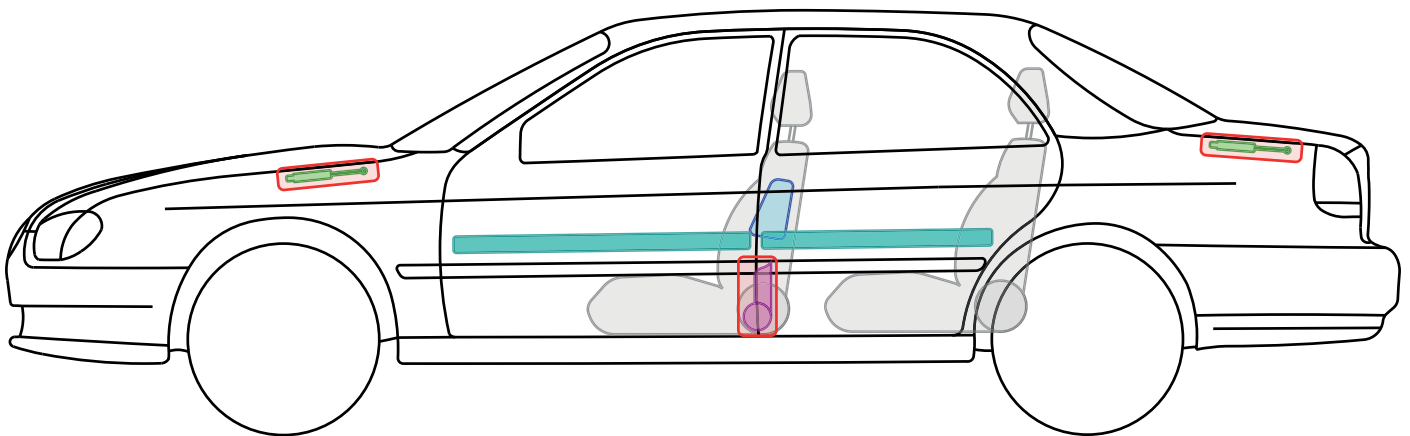
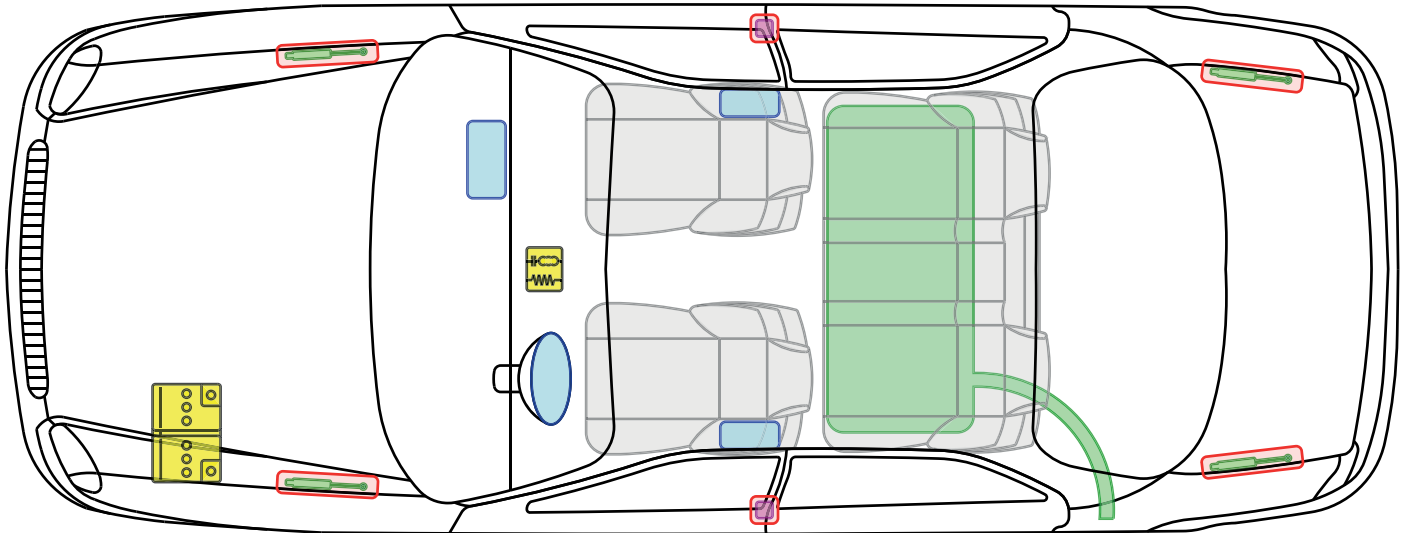

**Legende**

	Airbag		Karosserie- verstärkung		Steuergerät		Gastank
	Gas- generator		Überroll- schutz		12 V Batterie		Sicherheits- ventil
	Gurt- straffer		Gasdruck- dämpfer		Kraftstoff- tank		Fußgänger- schutzsystem

**(Grand) Santa Fe**

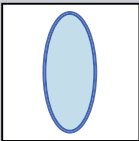
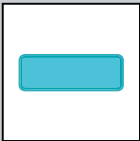

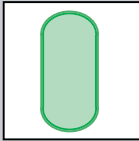
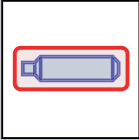
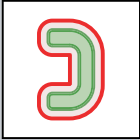
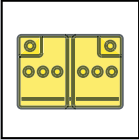
Legende

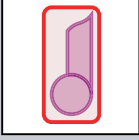
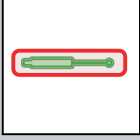
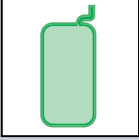
	Airbag		Karosserie- verstärkung		Steuergerät		Gastank
	Gas- generator		Überroll- schutz		12 V Batterie		Sicherheits- ventil
	Gurt- straffer		Gasdruck- dämpfer		Kraftstoff- tank		

**Sonata**



# Sonata 4-Türer

(Typ EF, 2001-2005)

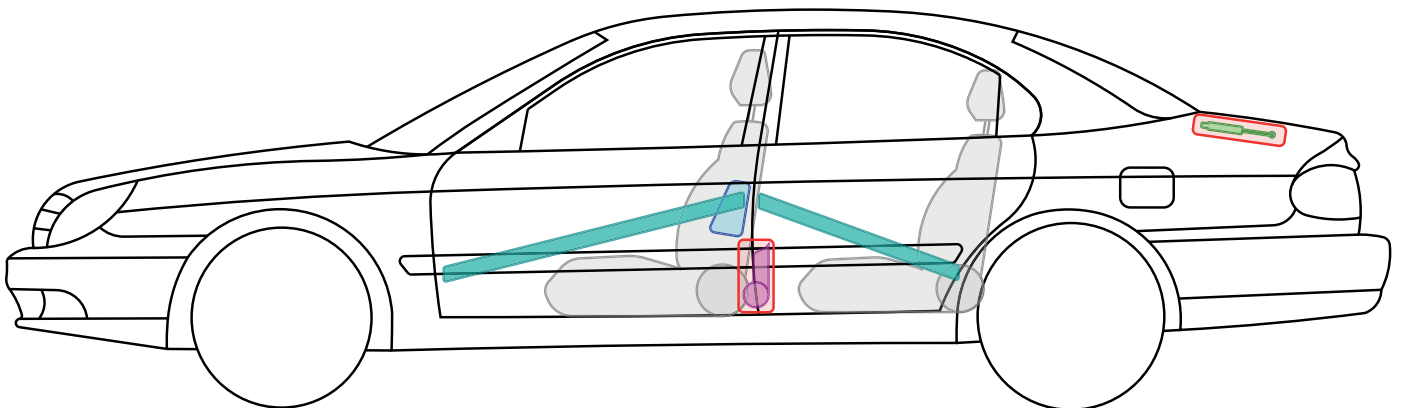
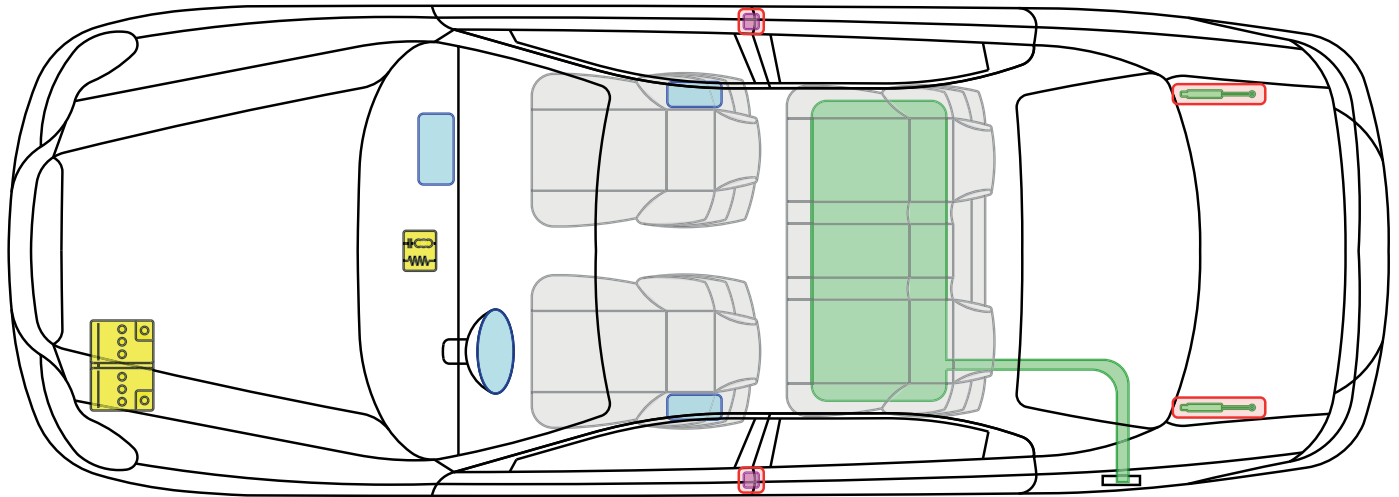



## Legende

	Airbag		Karosserie- verstärkung		Steuergerät		Gastank
	Gas- generator		Überroll- schutz		12 V Batterie		Sicherheits- ventil
	Gurt- straffer		Gasdruck- dämpfer		Kraftstoff- tank		

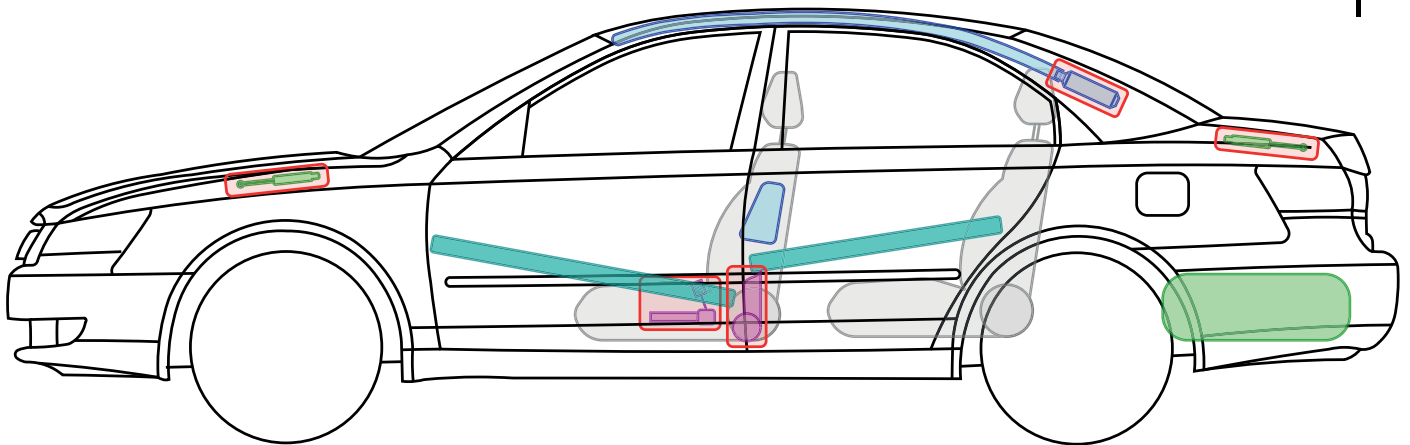
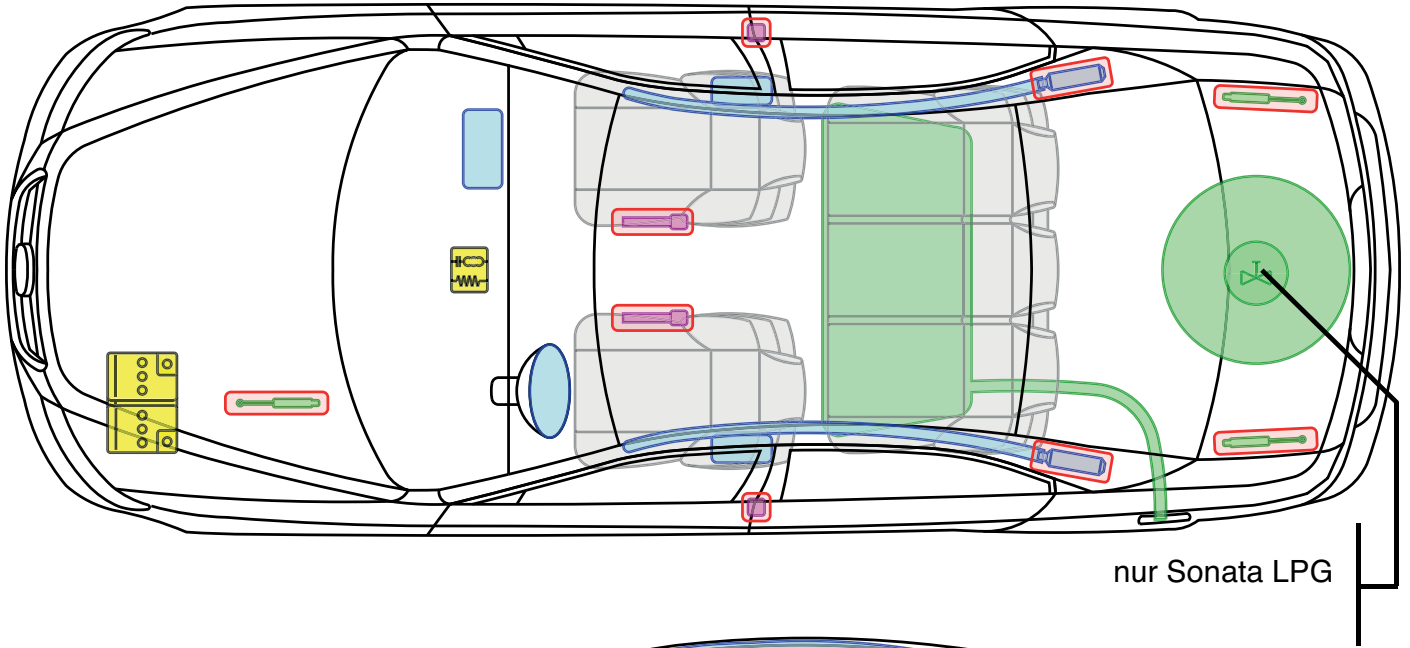
**Sonata**

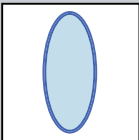
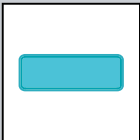

Legende

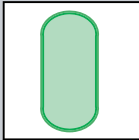
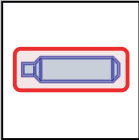
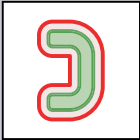
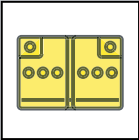
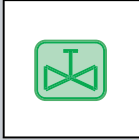
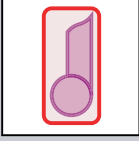
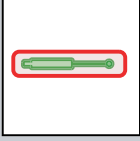
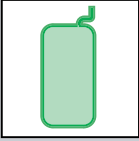

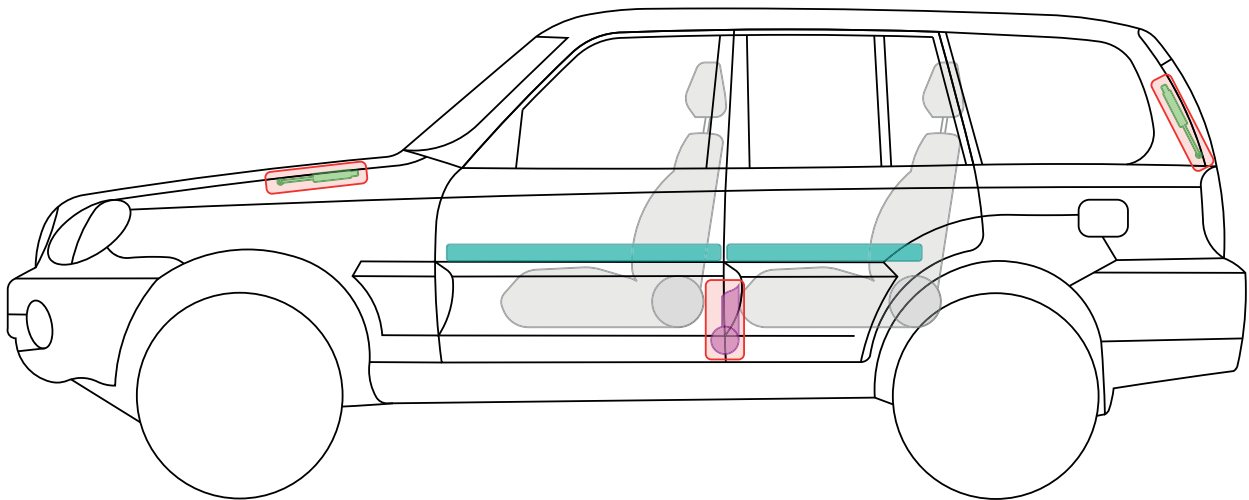
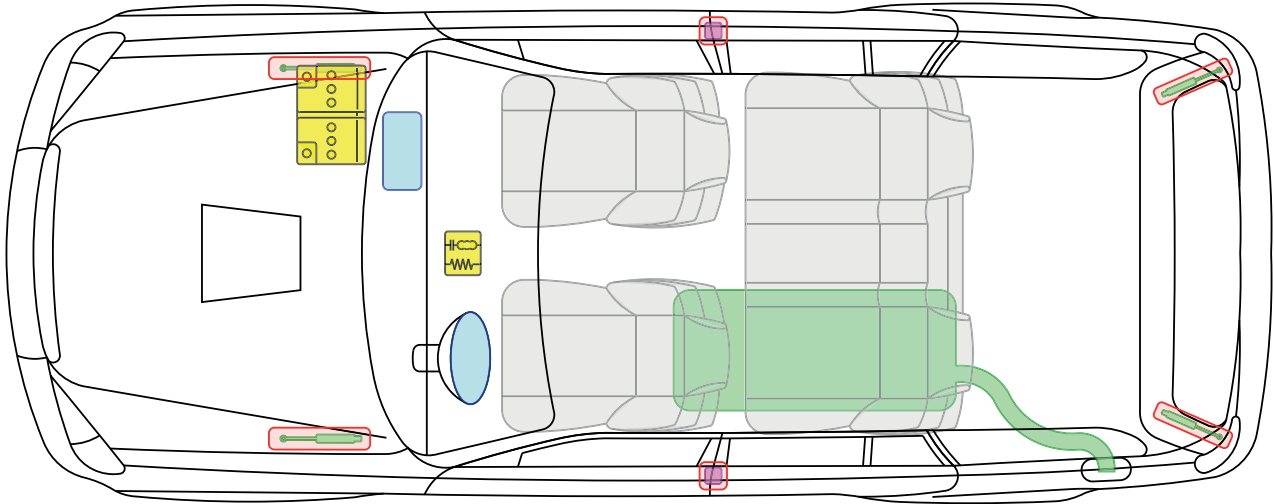

	Airbag		Karosserie- verstärkung		Steuergerät		Gastank
	Gas- generator		Überroll- schutz		12 V Batterie		Sicherheits- ventil
	Gurt- straffer		Gasdruck- dämpfer		Kraftstoff- tank		

**Sonata**



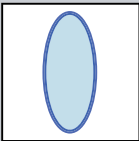
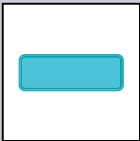

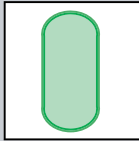
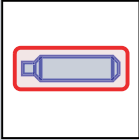
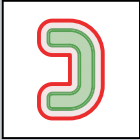
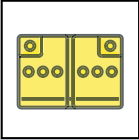

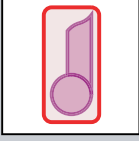
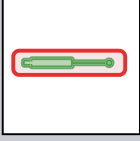
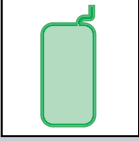

**Legende**

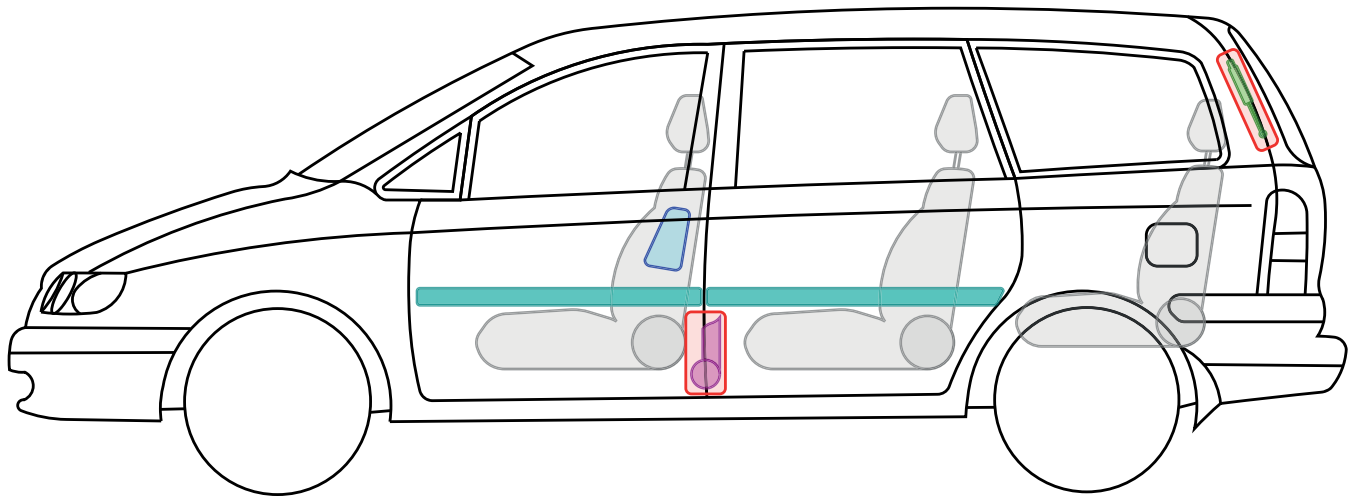
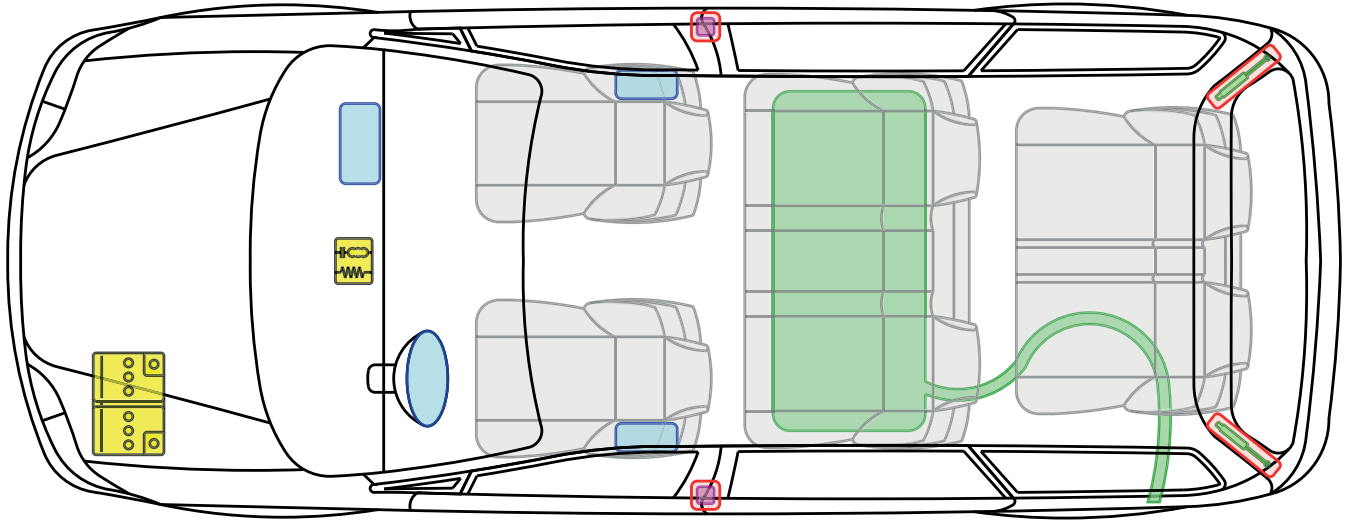
	Airbag		Karosserie- verstärkung		Steuergerät		Gastank
	Gas- generator		Überroll- schutz		12 V Batterie		Sicherheits- ventil
	Gurt- straffer		Gasdruck- dämpfer		Kraftstoff- tank		

**Terracan**

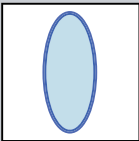
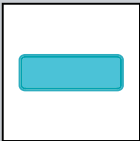

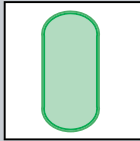
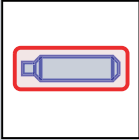
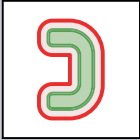
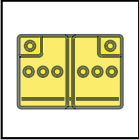
Legende

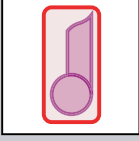
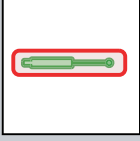
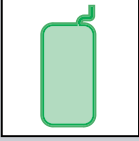
	Airbag		Karosserie- verstärkung		Steuergerät		Gastank
	Gas- generator		Überroll- schutz		12 V Batterie		Sicherheits- ventil
	Gurt- straffer		Gasdruck- dämpfer		Kraftstoff- tank		



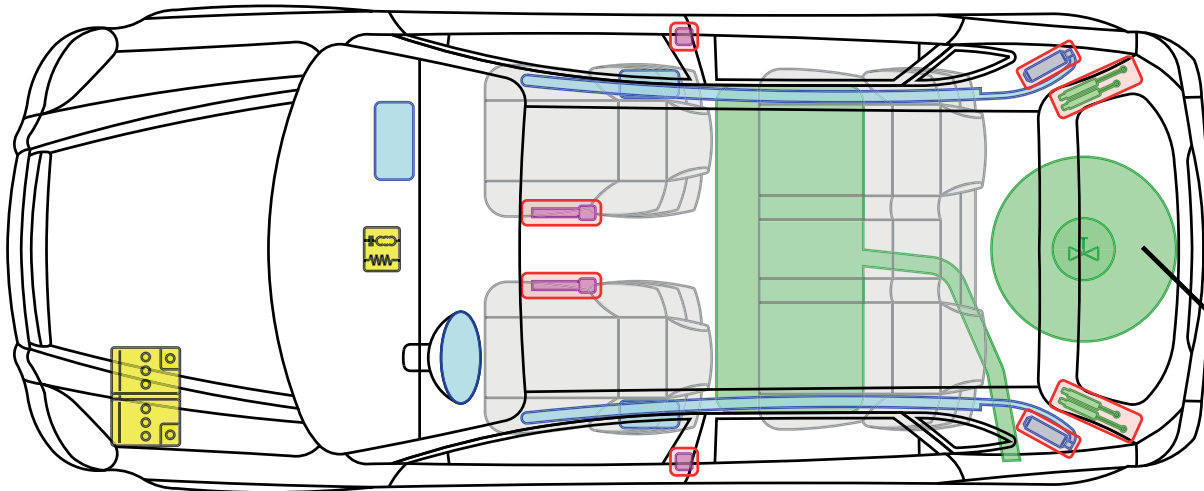

**Trajet**

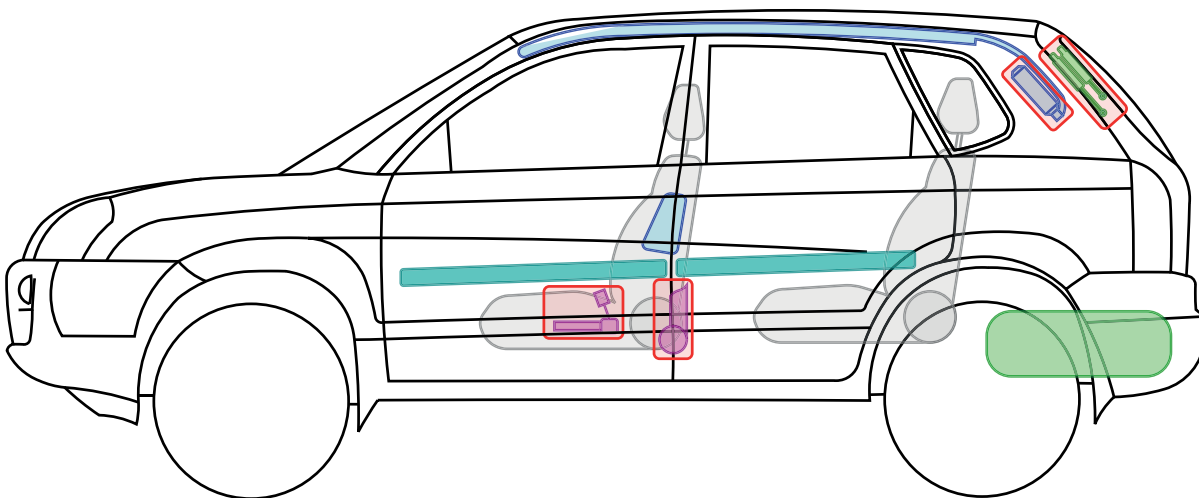

nur Tucson LPG

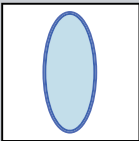
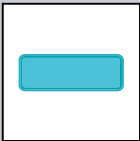

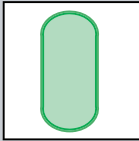
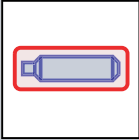
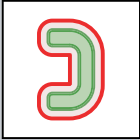
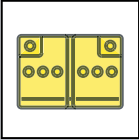

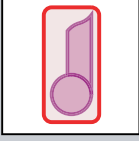
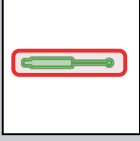
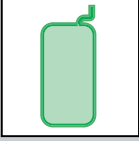

Legende

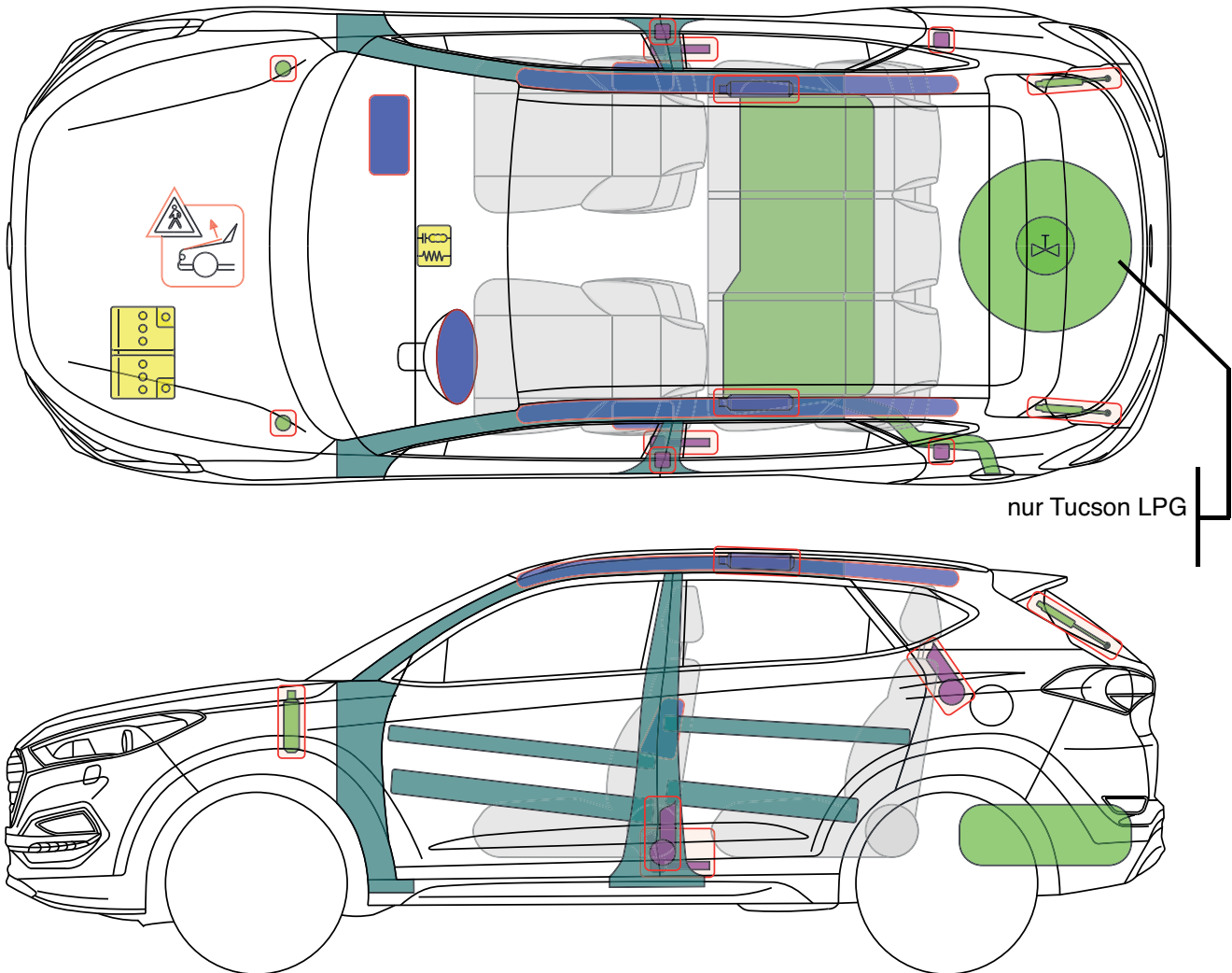
	Airbag		Karosserie- verstärkung		Steuergerät		Gastank
	Gas- generator		Überroll- schutz		12 V Batterie		Sicherheits- ventil
	Gurt- straffer		Gasdruck- dämpfer		Kraftstoff- tank		

**Tucson**

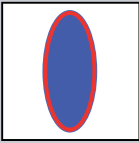
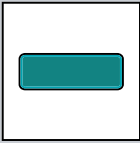
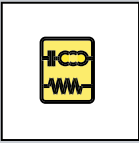
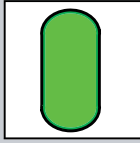
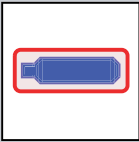

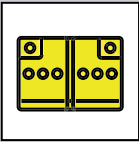
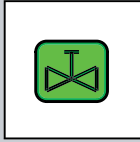
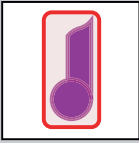
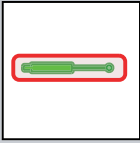



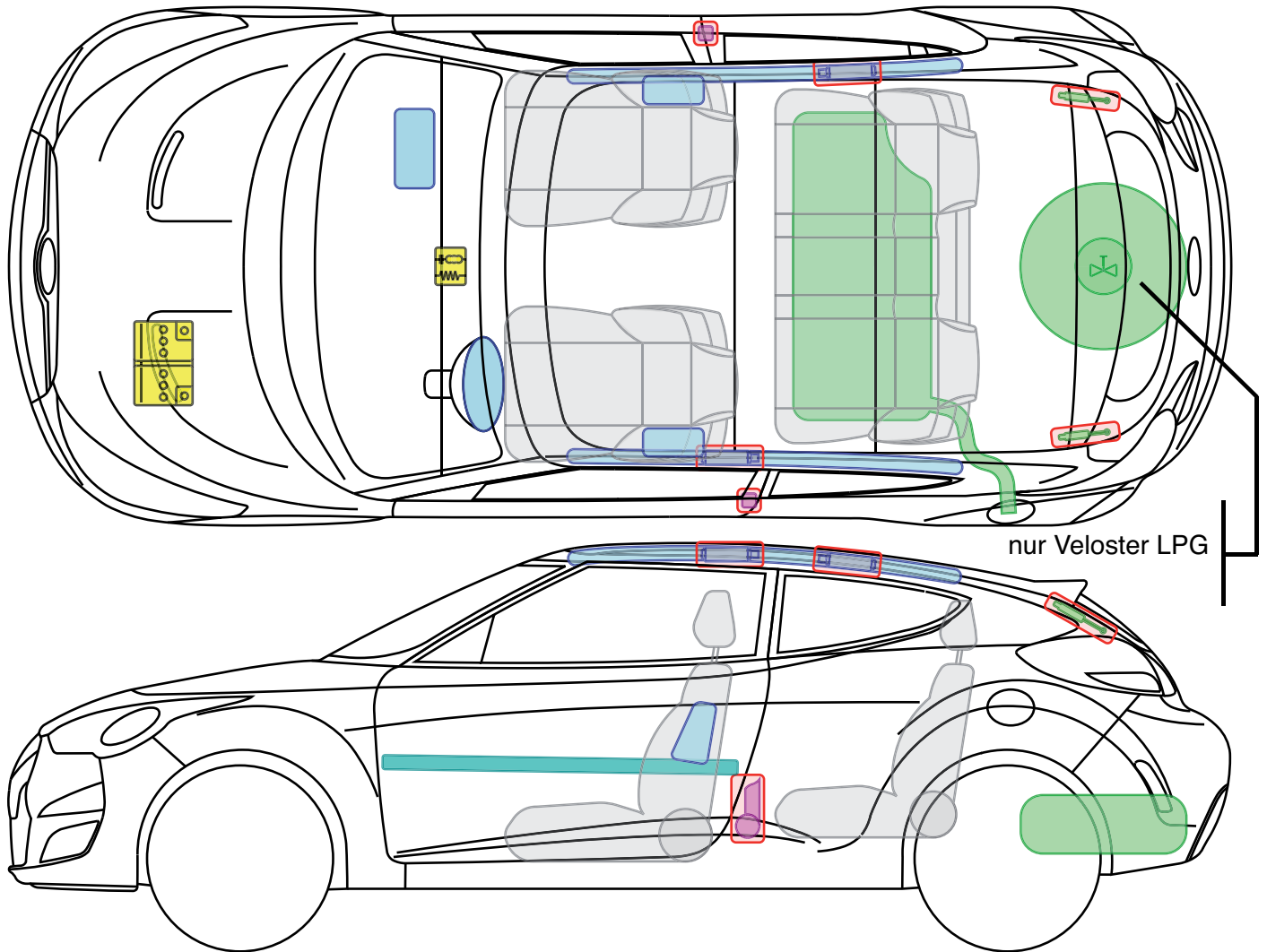

**Legende**

	Airbag		Karosserie- verstärkung		Steuergerät		Gastank
	Gas- generator		Überroll- schutz		12 V Batterie		Sicherheits- ventil
	Gurt- straffer		Gasdruck- dämpfer		Kraftstoff- tank		

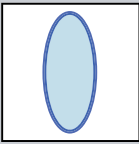
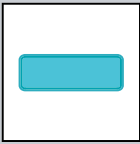
**Tucson**

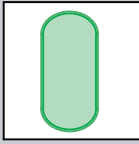
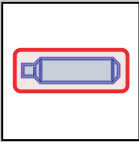
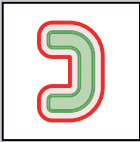
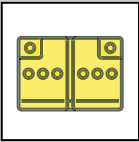

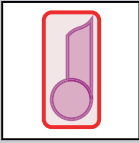
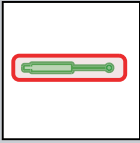

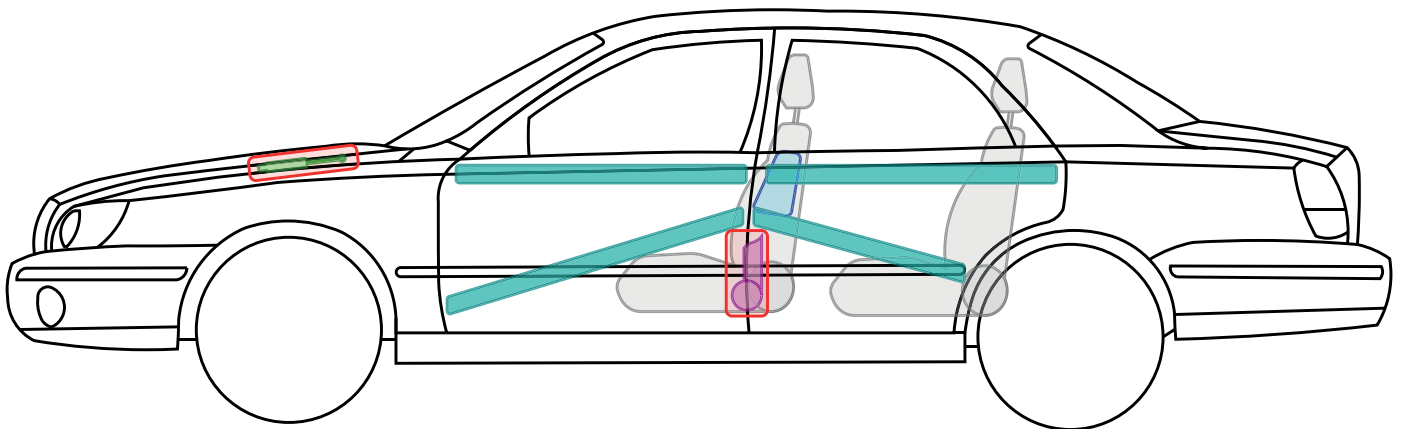
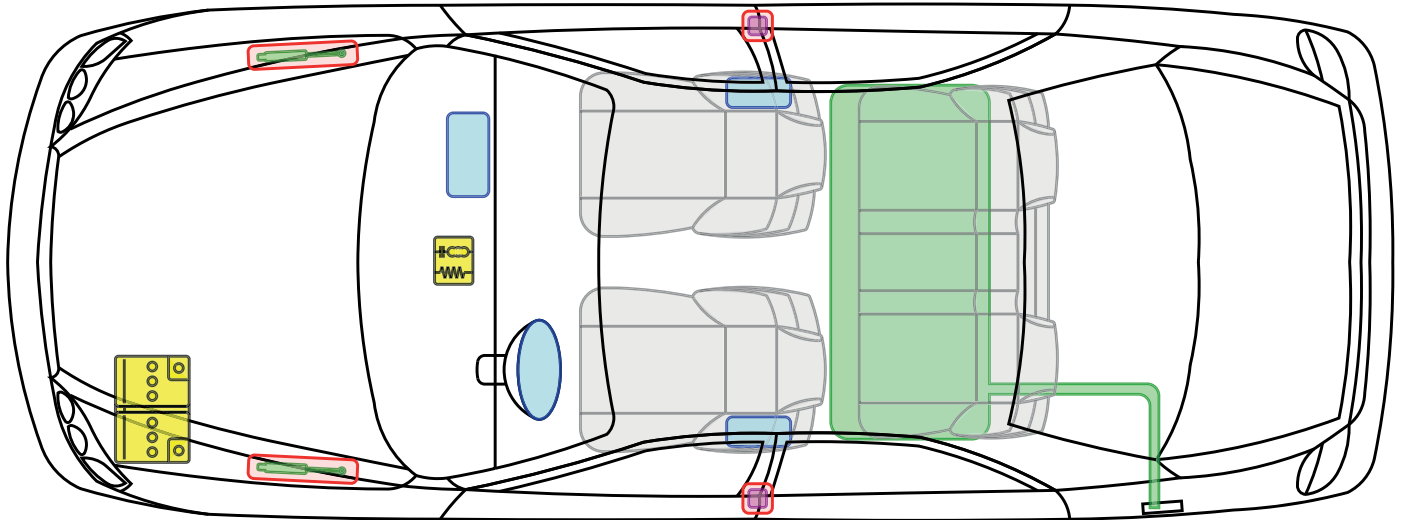

**Legende**

	Airbag		Karosserie- verstärkung		Steuergerät		Gastank
	Gas- generator		Überroll- schutz		12 V Batterie		Sicherheits- ventil
	Gurt- straffer		Gasdruck- dämpfer		Kraftstoff- tank		

**Veloster**

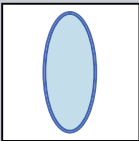
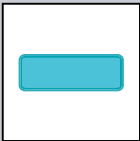

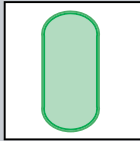
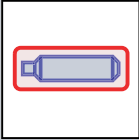
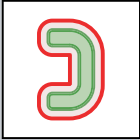
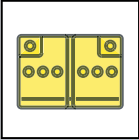
Legende

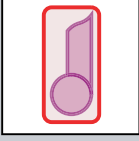
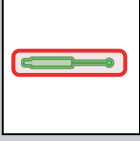
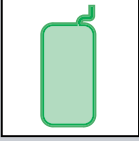
	Airbag		Karosserie- verstärkung		Steuergerät		Gastank
	Gas- generator		Überroll- schutz		12 V Batterie		Sicherheits- ventil
	Gurt- straffer		Gasdruck- dämpfer		Kraftstoff- tank		

**XG**